

Description

The MC1XAZ01 mounting card is designed to host an AZ or AZX series analog servo drive. This mounting card offers convenient quick-disconnect connectors (mating screw terminals included). Easily accessible test points are available for I/O and Feedback monitoring. The MC1XAZ01 can either be screw-mounted or attached to a standard DIN tray. The MC1XAZ01 is ideal for prototyping. The mounting card also features a keyed connector to prevent misaligned connections.

The MC1XAZ01 utilizes vertical-entry quick-disconnect screw terminals. For side-entry right angle connections use the MC1XAZ01-HR mounting card.

Drive Compatibility

AZ (Standard Environment)		AZX (Extended Environment)
80 V Models	175 V Models	80 V Models
20A	25A	25A
12A	10A	15A
6A		8A

*For 40A & 60A (80V) AZ series, use MC1XAZ01-HR



Features

- ▲ Mounts AZ & AZX Series Analog Servo Drives
- ▲ All Detachable Connections
- ▲ Lightweight
- ▲ Small Footprint
- ▲ Mating Connectors Included
- ▲ I/O, Feedback, and Ground Test Points
- ▲ Standard DIN Tray Dimensions
- ▲ Keyed Connector

DRIVES SUPPORTED

- AZBE25A20
- AZB25A20
- AZB10A20
- AZBE10A20
- AZB20A8
- AZBE20A8
- AZB12A8
- AZBE12A8
- AZB6A8
- AZBE6A8
- AZXB25A8
- AZXBE25A8
- AZXB15A8
- AZXBE15A8
- AZXB8A8
- AZXBE8A8
- AZBH25A20
- AZBDC25A20
- AZBDC10A20
- AZBH10A20
- AZBDC20A8
- AZBH20A8
- AZBDC12A8
- AZBH12A8
- AZBDC6A8
- AZBH6A8
- AZXBDC25A8
- AZXBH25A8
- AZXBDC15A8
- AZXBH15A8
- AZXBDC8A8
- AZXBH8A8

TEST POINTS

- Inputs/Outputs
- Feedback
- Ground

FEEDBACK SUPPORTED

- Incremental Encoder
- Hall Sensors
- Tachometer



COMPLIANCES & AGENCY APPROVALS

- CE Class A (EMC)
- CE Class A (LVD)
- RoHS II
- UL & cUL (optional)

SPECIFICATIONS

Mechanical Specifications		
Description	Units	Value
Agency Approvals	-	CE Class A (EMC), CE Class A (LVD), RoHS II, UL & cUL (optional)
Size (H x W x D)**	mm (in)	101.6 x 71.9 x 15.7 (4.00 x 2.83 x 0.54)
Weight (with mating connectors)	g (oz)	58.3 (2.1)
P1 Connector	-	16-pin, 2.54 mm spaced header
P2 Connector	-	22-pin, 2.54 mm spaced, dual-row header
P3 Connector	-	22-pin, 2.54 mm spaced, dual-row header
P4 Connector*	-	8-port, 3.5 mm spaced insert connector
P5 Connector*	-	8-port, 3.5 mm spaced insert connector
P6 Connector*	-	4-port, 5.08 mm spaced insert connector
P7 Connector*	-	3-port, 5.08 mm spaced insert connector

*Mating Connector Included
 **Depth value is without mating connectors. See mounting dimensions drawing for depth with mating connectors installed. The total depth with an AZ servo drive mounted on the card will be equivalent to the depth dimension of the servo drive (including pins). See specific drive datasheet mounting dimensions drawing for value.

Information on Approvals and Compliances	
	<p>UL approval optional based on customer request. Contact <i>ADVANCED</i> Motion Controls for more information.</p> <p>US and Canadian safety compliance with UL 508c, the industrial standard for power conversion electronics. UL registered under file number E140173. Note that machine components compliant with UL are considered UL registered as opposed to UL listed as would be the case for commercial products.</p>
	<p>Compliant with European CE for both the Class A EMC Directive 2004/108/EC on Electromagnetic Compatibility (specifically EN 61000-6-4:2007 and EN 61000-6-2:2005) and LVD requirements of directive 2006/95/EC (specifically EN 60204-1:2006), a low voltage directive to protect users from electrical shock.</p>
	<p>The RoHS II Directive 2011/65/EU restricts the use of certain substances including lead, mercury, cadmium, hexavalent chromium and halogenated flame retardants PBB and PBDE in electronic equipment.</p>

PIN FUNCTIONS

P1 – Mounting Signal Connector

This connector mates directly to the drive. For pin functions refer to the drive datasheet.

P2 – Mounting Power Connector

This connector mates directly to the drive. For pin functions refer to the drive datasheet.

P3 – Mounting Power Connector

This connector mates directly to the drive. For pin functions refer to the drive datasheet.

P4 – I/O Connector*

Pin	Name	Description	I/O
1	+REF IN / PWM IN	Analog Input Drives: Differential Reference Input PWM Input drives: Pulse width modulated digital input command	I
2	SIGNAL GND	Signal Ground	GND
3	-REF IN / PWM IN	Analog Input Drives: Differential Reference Input PWM Input drives: Direction Input	I
4	CURRENT MONITOR	Current Monitor. Analog output signal proportional to the actual current output. Measure relative to signal ground. See drive datasheet for scaling factor.	O
5	INHIBIT IN	TTL level (+5 V) inhibit/enable input. Leave open to enable drive. Pull to ground to inhibit drive. Inhibit turns off all power devices.	I
6	CURRENT REF OUT	Measures the command current to the internal current-loop. Measure relative to signal ground. See drive datasheet for maximum output voltage.	O
7	FAULT OUT	TTL level (+5 V) output becomes high when power devices are disabled due to at least one of the following conditions: inhibit, invalid Hall state, output short circuit, over voltage, over temperature, power-up reset.	O
8	VEL MONITOR OUT / TACH IN	Velocity Monitor. Analog output proportional to motor speed. See drive datasheet for scaling factor. For Tachometer Velocity mode, feedback voltage range is ± 60 VDC max.	O/I

*Not all functions are used on every drive model. Consult the drive datasheet to see which features are included.

P5 – Feedback Connector*

Pin	Name	Description	I/O
1	MOT ENC A	Single-ended Encoder Input A	I
2	MOT ENC B	Single-ended Encoder Input B	I
3	OFFSET	Connection to external resistance for command offset adjustments.	I
4	HALL 1	Single-ended Hall/Commutation Sensor Inputs (+5 V logic level)	I
5	HALL 2		I
6	HALL 3		I
7	SIGNAL GND	Signal Ground	GND
8	+V HALL OUT	Low Power Supply for Hall Sensors (+6 V @ 30 mA). Referenced to signal ground. Short circuit protected.	O

*Not all functions are used on every drive model. Consult the drive datasheet to see which features are included.

P6 – Motor Power Connector

Pin	Name	Description	I/O
1	MOTOR A	Motor Phase A.	O
2	MOTOR B	Motor Phase B.	O
3	MOTOR C	Motor Phase C.	O
4	CHASSIS	Chassis (PE Ground)	PE

P7 –Power Connector

Pin	Name	Description	I/O
1	POWER GND	Power Ground (Common with Signal Ground).	GND
2	HIGH VOLTAGE	DC Power Input.	I
3	CHASSIS	Chassis (PE Ground)	PE

MECHANICAL INFORMATION

P1 – Mounting Signal Connector

Connector Information	16-pin, 2.54 mm pitch header
Mating Connector	No mating connector required. Mate directly to drive.

P2 – Mounting Power Connector

Connector Information	22-pin, 2.54 mm pitch header
Mating Connector	No mating connector required. Mate directly to drive.

P3 – Mounting Power Connector

Connector Information	22-pin, 2.54 mm pitch header
Mating Connector	No mating connector required. Mate directly to drive.

P4 – I/O Connector

Connector Information	8-port, 3.5 mm spaced insert connector	
Mating Connector	Details	Phoenix Contact: P/N 1840421
	Included with Drive	Yes

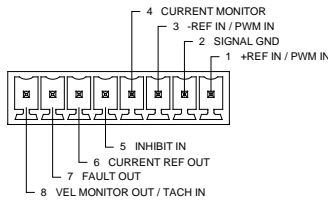

P5 – Feedback Connector

Connector Information	8-port, 3.5 mm spaced insert connector	
Mating Connector	Details	Phoenix Contact: P/N 1840421
	Included	Yes

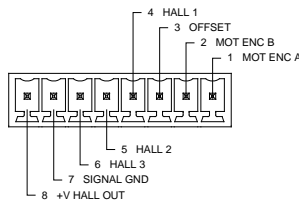

P6 – Motor Power Connector

Connector Information		4-port, 5.08 mm spaced insert connector
Mating Connector	Details	Phoenix Contact: P/N 1757035 or 1777303 (vertical screw terminal)
	Included	Yes

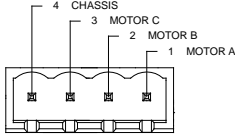

P7 – Power Connector

Connector Information		3-port, 5.08 mm spaced insert connector
Mating Connector	Details	Phoenix Contact: P/N 1757022 or 1777293 (vertical screw terminal)
	Included	Yes

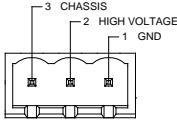

HARDWARE NOTES

The MC1XAZ01 mounting card is designed for easy installation and integration by means of quick disconnect screw-terminals and the ability to easily slide into a standard sized DIN mounting tray. The MC1XAZ01 can also be mounted to a panel or other plane surface by means of four screw-mount locations on the mounting card PCB. The photo below shows an AZ-series amplifier installed onto the MC1XAZ01, which is inserted in a DIN mounting tray, with I/O, Feedback, and Power mating connectors shown alongside (amplifier and mounting tray not included with MC1XAZ01 mounting card).

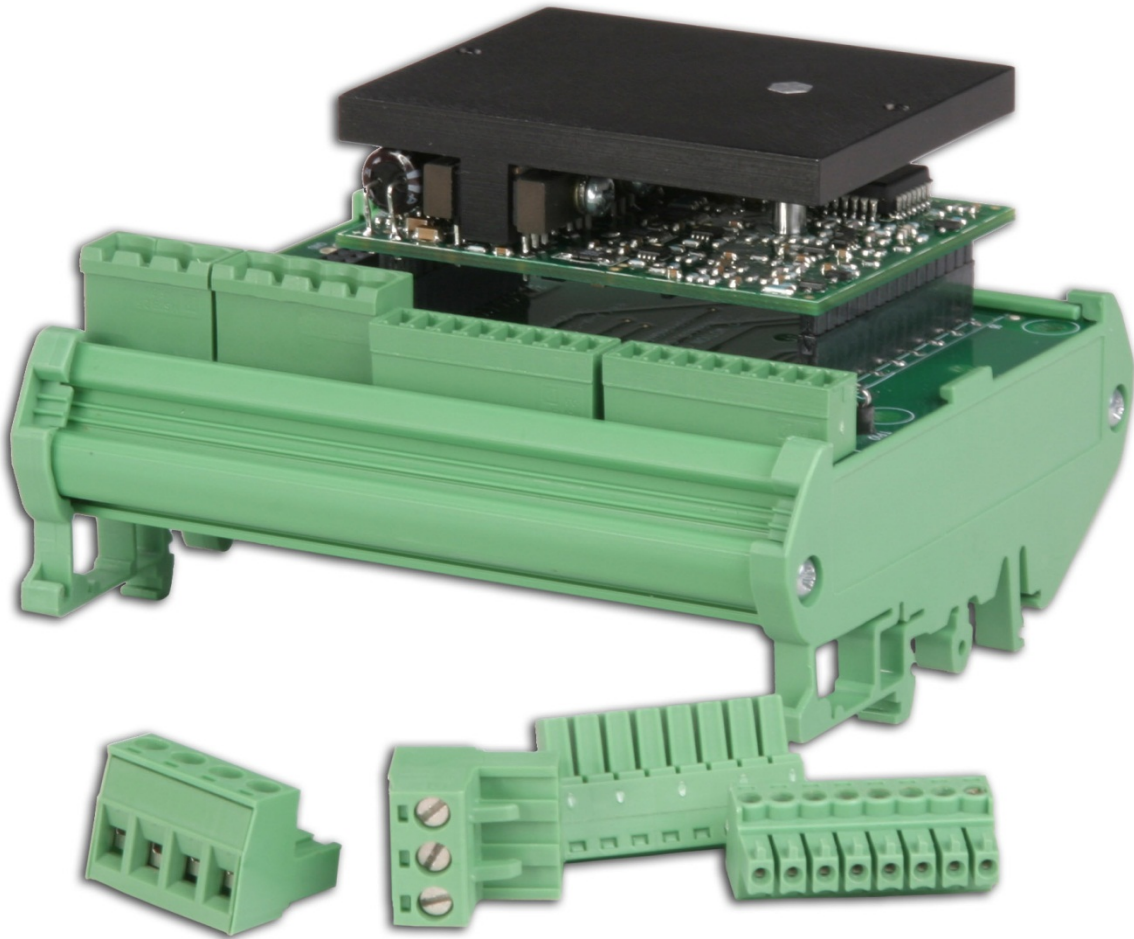
**DIN MOUNTING TRAY EXAMPLE:**

Manufacturer: Phoenix Contact ®

INCLUDED CONNECTORS:

Manufacturer: Phoenix Contact ®

3-position 5.08 mm spaced plug terminal (1 quantity, manufacturer part number: 1757022)

4-position 5.08 mm spaced plug terminal (1 quantity, manufacturer part number: 1757035)

8-position 3.5 mm spaced plug terminal (2 quantity, manufacturer part number: 1840421)

MOUNTING DIMENSIONS

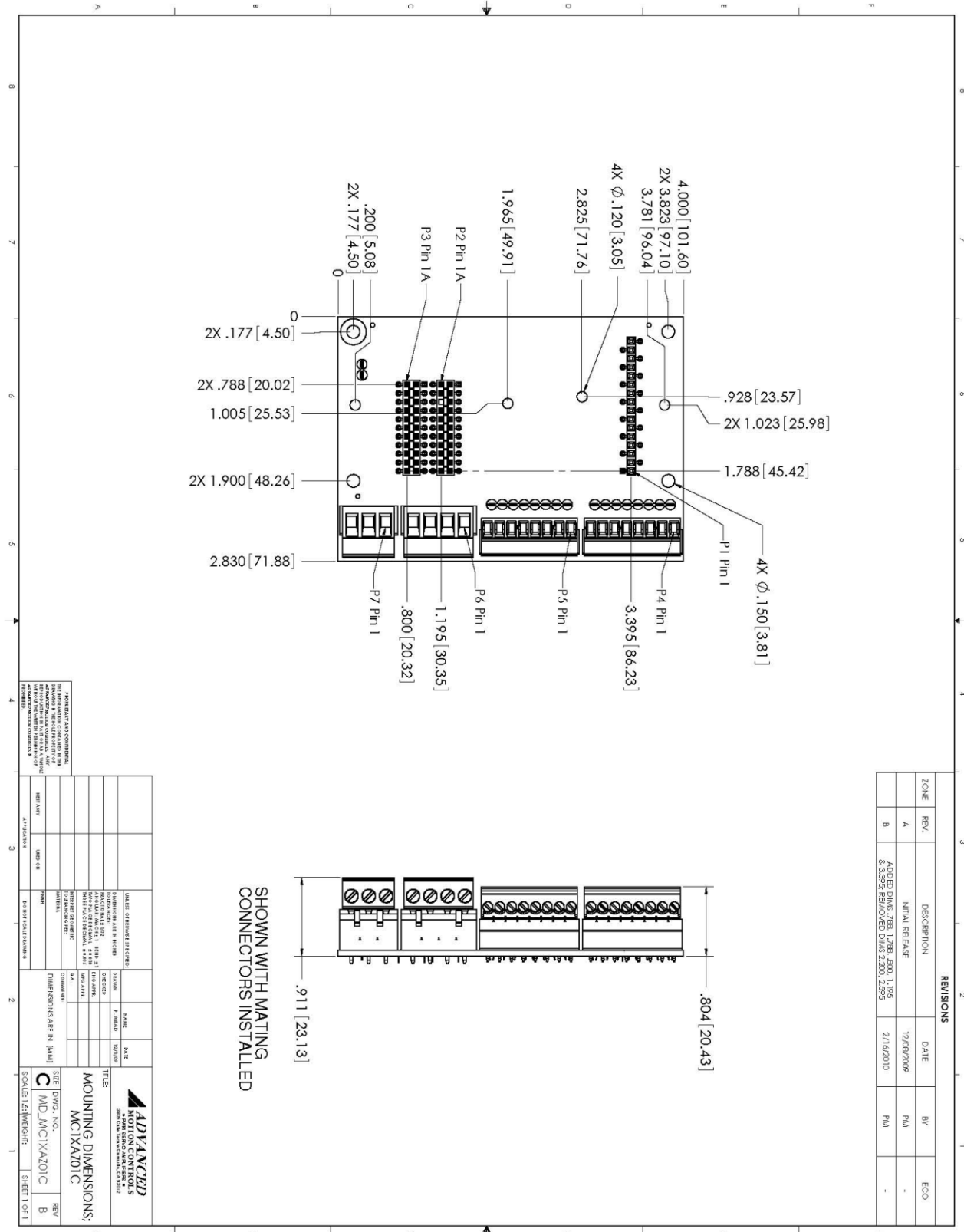

REVISIONS			
ZONE	REV.	DESCRIPTION	DATE
A		INITIAL RELEASE	12/09/2009
B		ADDED DIMS: 788, 1.788, .800, 1.195 & 3.395; REMOVED DIMS: 2.200, 2.959	2/16/2010

DATE	BY	ECO

DATE	BY	REV

DATE	BY	REV

PART NUMBERING INFORMATION

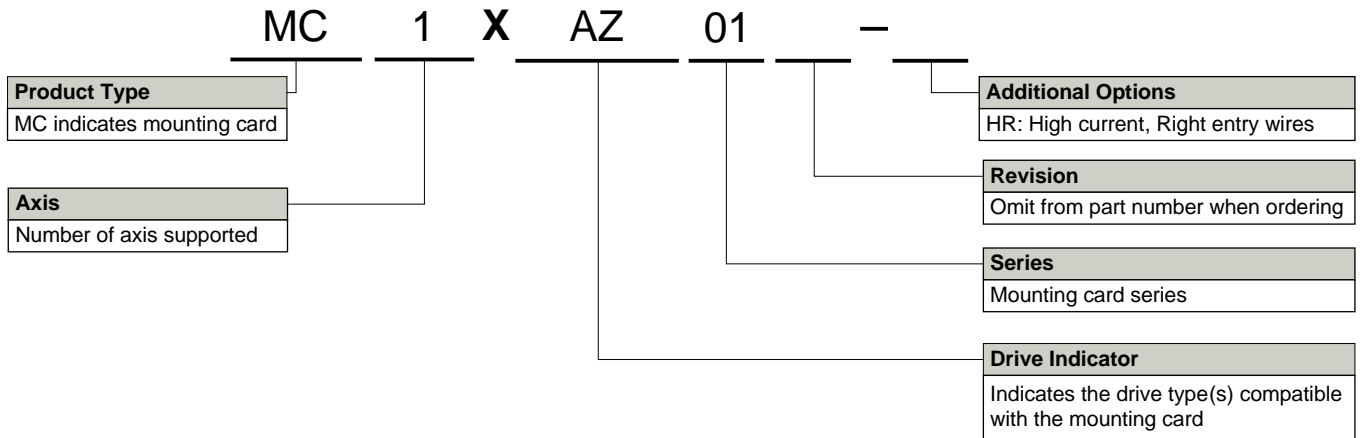

All analog servo drive accessories listed in the selection tables of the website are readily available, standard product offerings. However, additional features and/or options are available for select drives and other possibilities can be made available for OEMs with sufficient volume requests. Feel free to contact Applications Engineering for further information and details.

All specifications in this document are subject to change without written notice. Actual product may differ from pictures provided in this document.