

Sold & Serviced By:

SERVO2GO.com

Toll Free Phone: 877-378-0240

Toll Free Fax: 877-378-0249

sales@servo2go.com

KOLLMORGEN servo2go.com



SERVODISC™ CATALOG

A new dimension in performance

If you are involved with high performance servomotor applications, there is an important motor technology which you should know about. It's the technology found in ServoDisc motors from Kollmorgen.

What separates the ServoDisc motor from conventional DC servos is its ironless disc armature. As we shall see, this difference enables ServoDisc motors to deliver a level of performance, in both incremental motion and continuous speed applications, which is not attainable with conventional ironcore motor designs.

In addition to performance advantages, ServoDisc motors have a unique compact shape that can be an attractive alternative when solving tight packaging problems.

Unique ironless design

In a conventional slot-wound servomotor, the armature is constructed from a heavy, laminated ironcore wound with coils of wire. In a ServoDisc motor, the armature has no iron. Instead, it is constructed from several layers of copper conductors in a unique flat-disc configuration.

Not only are the armature designs completely different, so is the shape and internal construction. In a conventional servo, the permanent magnets are mounted on the motor shell creating a radial magnetic field, perpendicular to the shaft (Fig. 1). Because the magnet pairs are so far apart, the iron core of the armature is needed to contain and focus the lines of magnetic flux. Motors of this type are typically long, thin and heavy.

In a ServoDisc motor, the magnets are mounted on the end plates creating an axial magnetic field, parallel to the shaft.

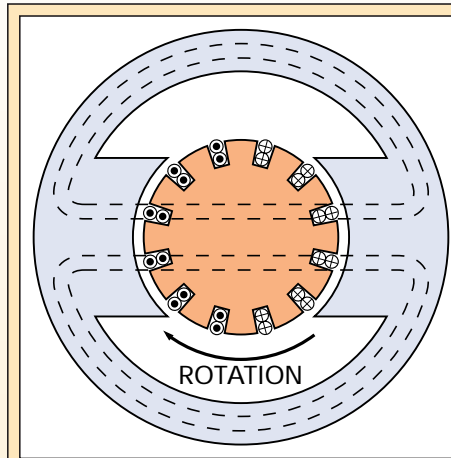

Ironcore Motor

A conventional ironcore motor uses a radial design with magnets placed concentrically around the shaft in such a way as to produce a radial magnetic field. (Fig. 1) The armature consists of slotted steel laminations wound with coils of wire which interact with the magnetic field to produce torque. As the motor rotates a commutator automatically maintains the correct current flow. A ServoDisc motor uses entirely different physical construction. The motor is designed with the magnetic field aligned axially, parallel to the shaft. (Fig. 2) The conductors in the arma-

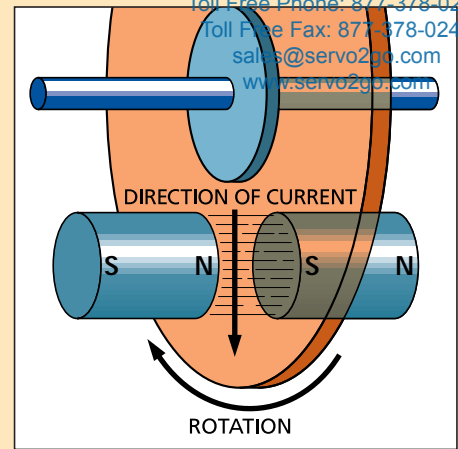

ServoDisc Motor

ture have a current flow which is perpendicular to the magnetic field (radial to the shaft). This produces a torque perpendicular to both the magnetic field and the current (the left-hand rule). This force rotates the shaft. This construction approach is much more efficient than the radial design of conventional ironcore motors and eliminates the heavy iron armature and the electrical losses associated with it. The large number of commutations possible with Kollmorgen's unique flat armature produce dramatically smoother torque output.

This leads to a very small air gap between the magnets, separated only by the thickness of the disc armature - a very clean and effective design approach. Torque is created when the current flowing radially through the copper conductors interacts directly with the field of the permanent magnets (Fig. 2). This configuration is a very efficient way of producing torque. These different approaches produce dramatically different motors (Fig. 3).

Outdistances other DC servos

The iron-free ServoDisc armature provides some significant performance advantages for motion control applications.

COMPARISON OF PERFORMANCE FEATURES



Size

The ServoDisc armature is much smaller and lighter than bulky ironcore designs of equivalent output.

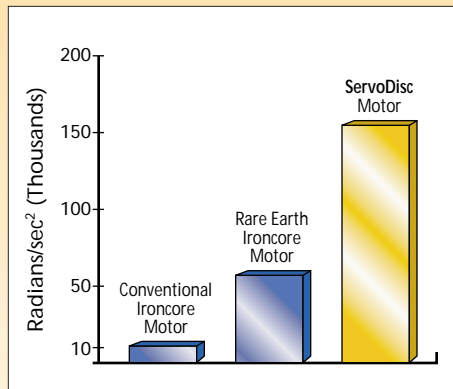

Acceleration

ServoDisc motors accelerate up to 10 times faster than conventional servo motors.

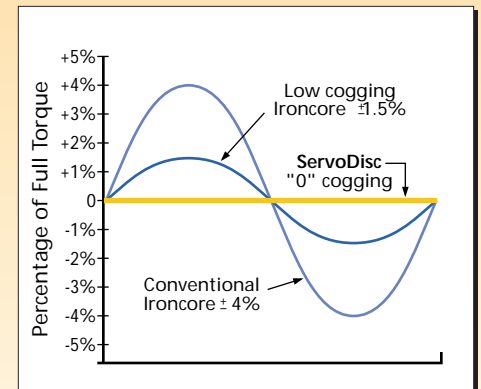

Cogging

The ironless ServoDisc armature has absolutely no cogging at any speed of operation.

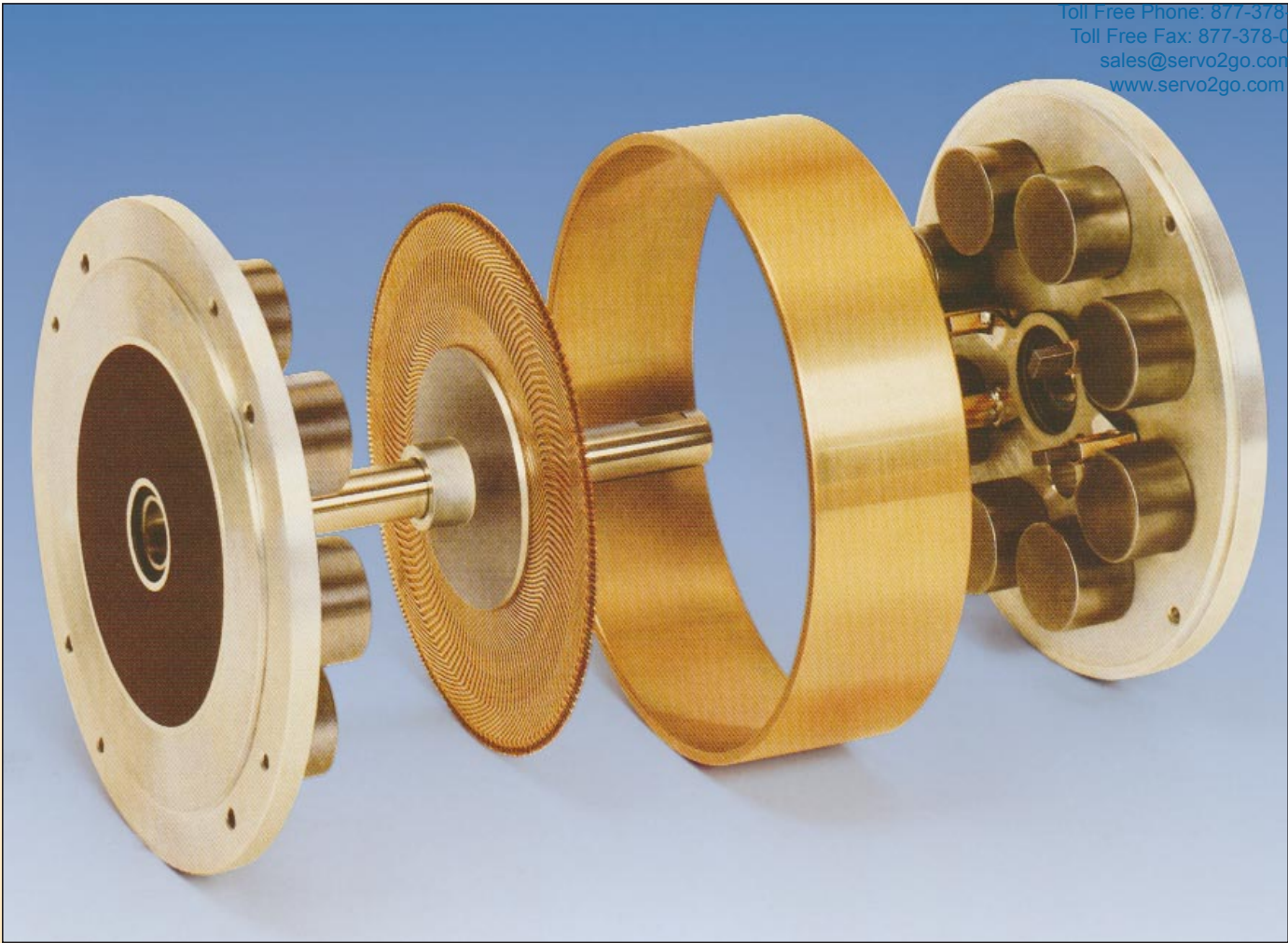

Faster acceleration

The thin, low-inertia armature design leads to exceptional torque-to-inertia ratios. This translates into blazing acceleration (Fig. 4). A typical ServoDisc motor can accelerate from 0 to 3000 rpm in only 60 degrees of rotation. In some applications,

the entire move can be performed in less than 10 milliseconds. This means shorter cycle times, more moves per second and higher throughput. For incremental motion applications, this translates into higher productivity and more profitability.

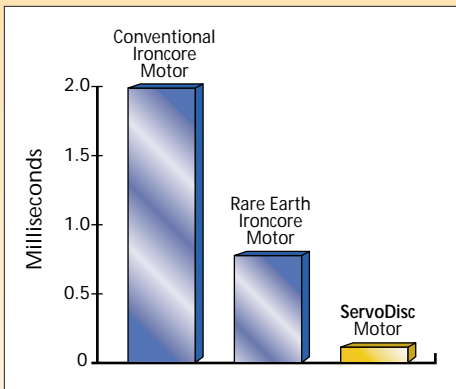

Electrical Time Constant

A very low electrical time constant results in torque much sooner than with conventional wire-wound motors.

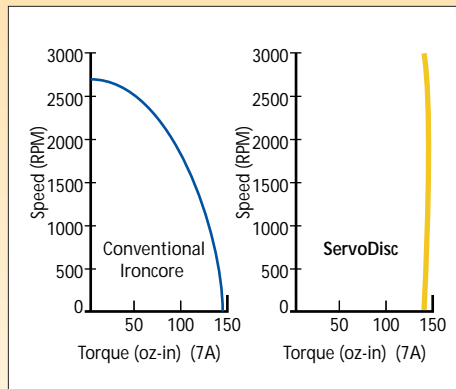

Torque-Speed Curves

With full torque from 0 to full speed, ServoDisc motors solidly outperform conventional motors.

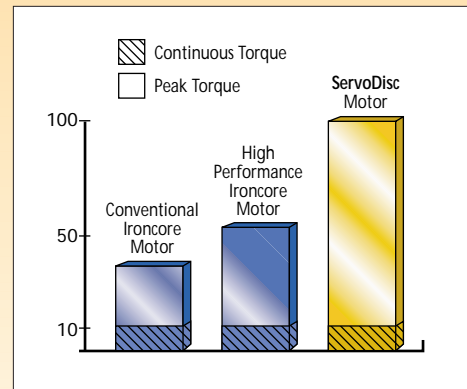

Peak Torque Capability

High peak torque capability means more throughput than is available from standard servos.

INTRODUCTION



- 69 to 143 oz-in (36-101 N-cm) Continuous Torque
- 4.37 to 5.5" OD Round Frame
- Optional Tachometer and Encoder Feedback
- Ultrathin Compact Size for Easy Design Integration

N-Series ServoDisc motors employ the unique Kollmorgen flat disc armature and high-energy neodymium-iron-boron magnets resulting in an ultra-thin motor. The ironless, low inertia armature delivers high acceleration and zero cogging.

- Neodymium magnet technology
- Fast Acceleration for higher throughput
- Extremely good speed control, zero cogging and low RFI
- Long brush life
- Flat ServoDisc motors are ideal for many applications:
 - Save space and weight in applications requiring a low profile motor
 - Large torsional stiffness for precision control of speed and acceleration
- Options:
 - With or without integral tachometer
 - Optical encoder
 - Brake

Compatible Products

- KXA Plus Amplifier
- EM19 Linear Amplifier

N-Series ServoDisc

PERFORMANCE DATA

Performance Specifications	Symbol	Units	N9M4	N9M4T	N9M4LR	N9M4LRT	N12M4	N12M4T	N12M4LR	N12M4LRT
Peak Torque	T_p	oz-in	760	692	729	663	1598	1386	1522	1320
		N-cm	537	489	515	468	1128	979	1075	932
Rated Speed	N	RPM	3000	3000	3000	3000	3000	3000	3000	3000
		oz-in	69	57	63	51	143	126	131	115
Rated Continuous Torque @ 25°C	T_{25}	N-cm	49	40	44	36	101	89	93	81
		oz-in	63	52	57	46	131	112	117	103
Rated Continuous Torque @ 40°C	T_{40}	N-cm	44	37	40	32	93	79	83	73
		Watts	153	126	140	114	316	278	291	256
Rated Power Output	P	Watts	153	126	140	114	316	278	291	256
Maximum Recommended Speed	N _{max}	RPM	6000	6000	6000	6000	6000	6000	6000	6000
Continuous Stall Torque	T_s	oz-in	69	62	62	56	147	128	136	117
		N-cm	49	44	44	40	104	90	96	83
Cogging Torque	T_c	oz-in	0	0	0	0	0	0	0	0

Electrical Specifications

Rated Terminal Voltage	E	Volts	30.0	28.0	16.0	14.0	51.0	45.0	26.0	23.0
Rated Continuous Current	I	Amps	7.80	7.10	14.00	12.90	8.00	8.10	14.80	15.00
Peak Current	I_p	Amps	79	77	151	147	83	83	159	159
Continuous Stall Current	I_s	Amps	7.5	7.3	13.7	13.3	8.0	8.0	14.7	14.7

Winding Specifications

Terminal Resistance ± 10%	R_t	Ohms	0.850	0.850	0.370	0.370	0.750	0.750	0.310	0.310
Armature Resistance ± 10%	R_a	Ohms	0.660	0.660	0.180	0.180	0.610	0.610	0.170	0.170
Back EMF Constant ± 10%	K_e	V/KRPM	7.60	7.10	3.80	3.60	15.10	13.10	7.60	6.60
Torque Constant ± 10%	K_t	oz-in/Amp	10.30	9.60	5.10	4.80	20.40	17.80	10.20	8.90
		N-cm/Amp	7.27	6.78	3.60	3.39	14.41	12.57	7.20	6.28
Viscous Damping Constant	K_d	oz-in/KRPM	1.1	1.1	1.1	1.1	2.8	2.3	2.7	2.2
		N-cm/KRPM	0.8	0.8	0.8	0.8	2.0	1.6	1.9	1.5
Armature Inductance	L	μH	<0.03	<0.03	<0.03	<0.03	<0.05	<0.05	<0.05	<0.05
Temperature Coefficient of KE	C	%/°C Rise	-0.10	-0.10	-0.10	-0.10	-0.10	-0.10	-0.10	-0.10
Number of Commutator Bars	Z		117	117	117	117	141	141	141	141

Mechanical Specifications

Moment of Inertia	J_m	oz-in-sec ²	0.0056	0.0083	0.0056	0.0083	0.0190	0.0260	0.0190	0.0260
		kg-cm ²	0.40	0.59	0.40	0.59	1.34	1.84	1.34	1.84
Static Friction Torque	T_f	oz-in	4.0	4.5	4.0	4.5	5.5	5.5	5.5	5.5
		N-cm	2.8	3.2	2.8	3.2	3.9	3.9	3.9	3.9
Weight	W	lbs	3.1	3.2	3.1	3.2	5.3	5.3	5.3	5.3
		kg	1.4	1.5	1.4	1.5	2.4	2.4	2.4	2.4
Diameter	D	in	4.37	4.37	4.37	4.37	5.50	5.50	5.50	5.50
		mm	111.0	111.0	111.0	111.0	139.7	139.7	139.7	139.7
Length	LG	in	0.94	0.95	0.94	0.95	1.07	1.10	1.07	1.10
		mm	23.9	24.1	23.9	24.1	27.2	27.9	27.2	27.9

Figure of Merit

Peak Acceleration	A_p	kRad/s ²	135.7	83.3	130.1	79.9	84.1	53.3	80.1	50.8
Mechanical Time Constant	T_m	ms	4.90	8.30	5.20	8.80	3.90	7.10	4.20	7.70
Electrical Time Constant	T_e	ms	<0.05	<0.05	<0.17	<0.17	<0.07	<0.07	<0.27	<0.27
Continuous Power Rate	P_c	kW/sec	6.0	2.8	5.0	2.2	7.6	4.3	6.4	3.6

Thermal Specifications

Thermal Resistance at Rated Speed	RAAR	°C/Watt	1.50	1.70	1.50	1.70	1.40	1.40	1.40	1.40
Thermal Resistance at Stall	RAAS	°C/Watt	2.00	2.10	2.00	2.10	1.90	1.90	1.90	1.90

Tachometer Specifications

Output Voltage	V	Volts/KRPM	—	3.50	—	3.50	—	5.90	—	5.90
Maximum Ripple Peak to Peak	V_{rh}	%	—	3.0	—	3.0	—	3.0	—	3.0
Linearity of Output Voltage	LIN	%	—	0.06	—	0.11	—	0.11	—	0.11
Minimum Load Resistance	R_l	Ohms	—	370	—	370	—	494	—	494

Notes:

- All values are based upon a 150°C armature temperature limit and with the motor mounted on an 8" x 16" x 3/8" aluminum heatsink with no forced air cooling. Other voltages, speeds, and torques, and duty cycles are achievable as long as the max armature temperature of 150°C is not exceeded.
- Mass air flow (lbs/min) = air volume (CFM) x air density (lbs/ft³).
- Terminal resistance is measured at 4.0 amps. RT varies as a function of applied current.
- Unless otherwise noted, all specifications above apply at 25°C.
- Peak torque and current is calculated based on max pulse duration of 50 milliseconds and a 1% duty cycle.
- The operating voltage can be calculated as: $I = (\text{Shaft torque} + T_f + K_D \times N/1000) / K_T$.
- The operating voltage can be calculated as: $V = K_E \times (N/1000) + R_T \times I$.
- Tachometer ripple measured with a resistive load of 1 kohm and a single low pass filter with 3db cut off at 500 Hz.
- Bidirectional tolerance of tachometer will not exceed 3%.

PERFORMANCE DATA

N9M4

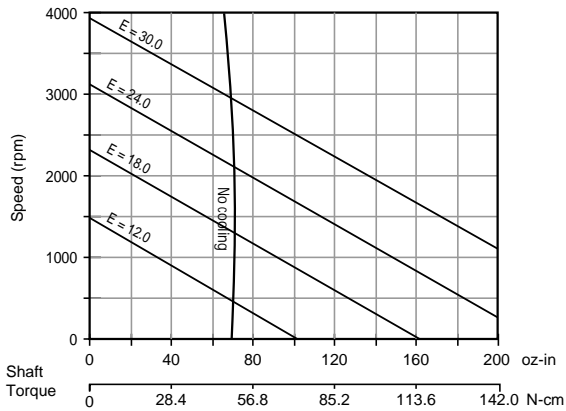

N9M4T

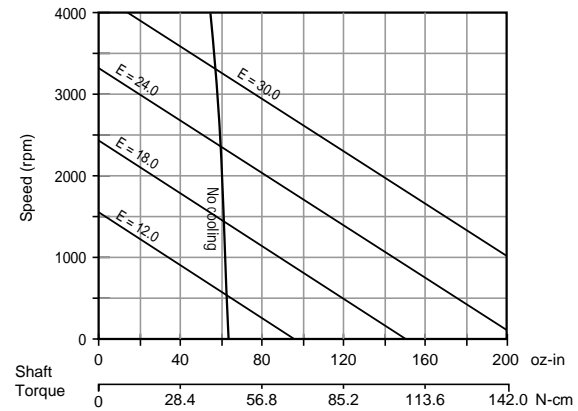

N12M4

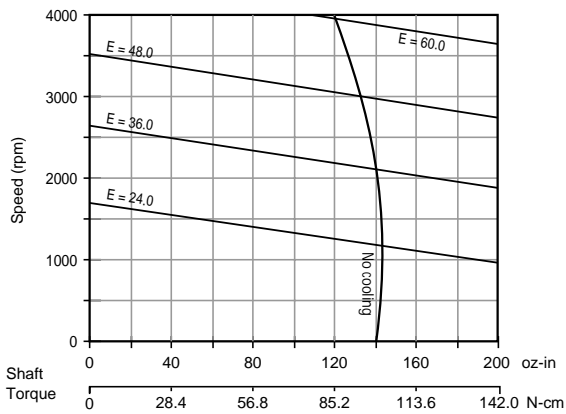

N12M4T

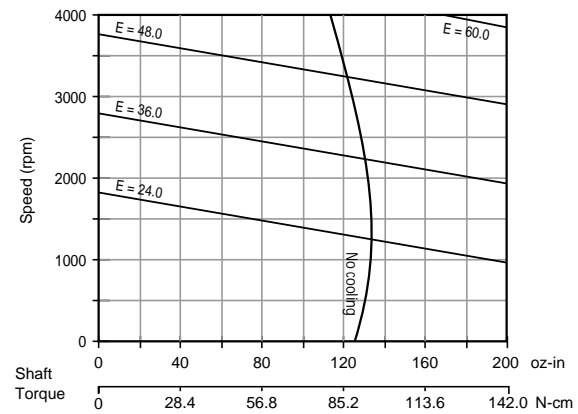

N9M4LR

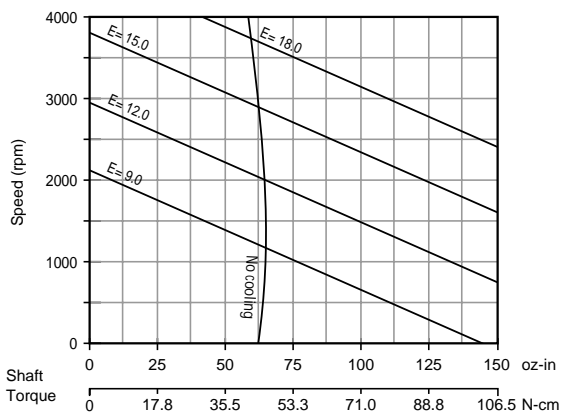

N9M4LRT

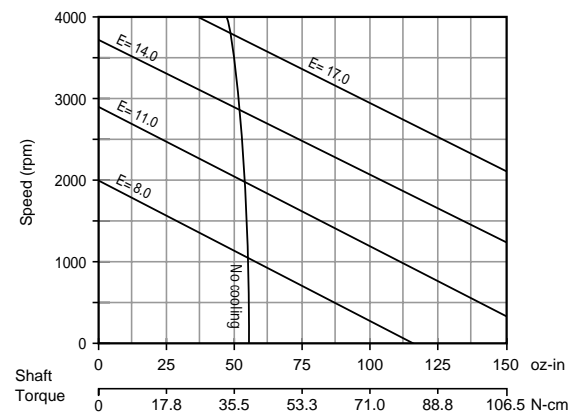

N-Series ServoDisc

0240
249

DIMENSIONS

sales@servo2go.com
www.servo2go.com

N12M4LR

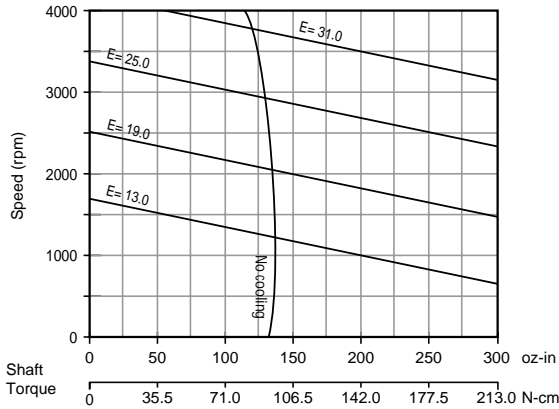

N12M4LRT

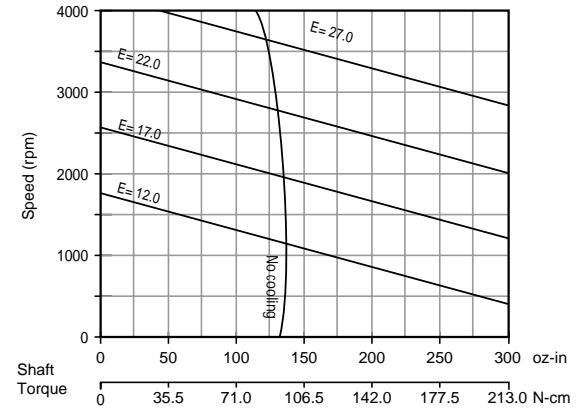

Notes:

- A. All curves are drawn for a fixed armature temperature of 150°C.
- B. The motor can be operated at any point on the graph below 4000 RPM. Higher speeds are possible for some applications. Contact a Kollmorgen Sales Office for more details.
- C. Determine voltage required for a desired combination of speed and torque by estimating it as a line parallel to one of the constant terminal voltage (E) lines.
- D. The operating current can be calculated as:

$$I = (\text{Shaft torque} + TF + KD \times N/1000)/KT.$$
- E. The operating voltage can be calculated as:

$$V = KE \times N/1000 + RT \times I.$$

N9M4/N9M4T

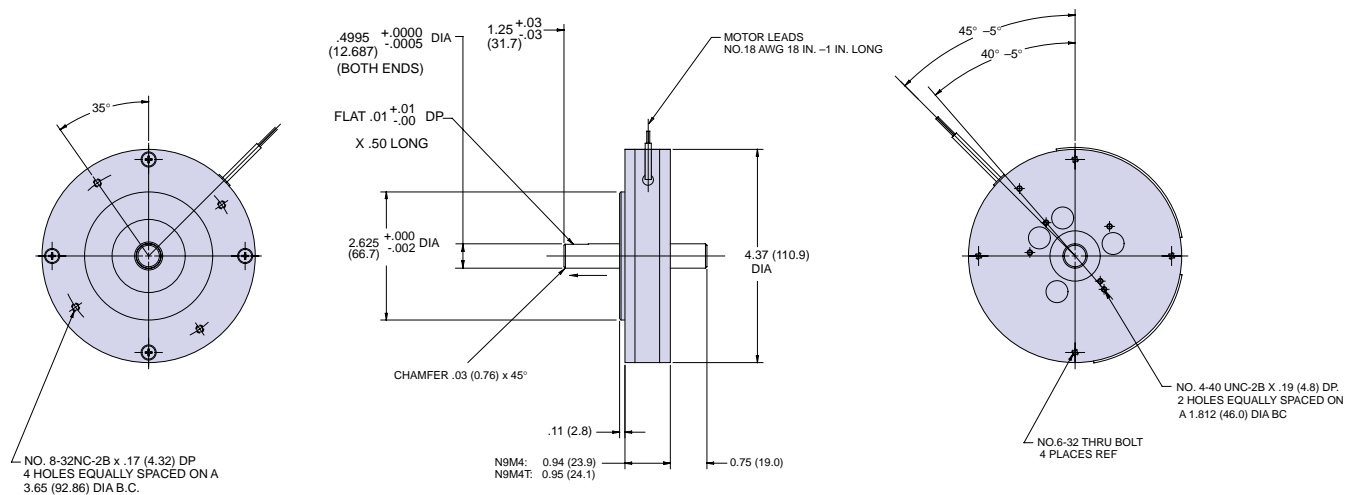

PERFORMANCE DATA

sales@servo2go.com
www.servo2go.com

N12M4/N12M4T

