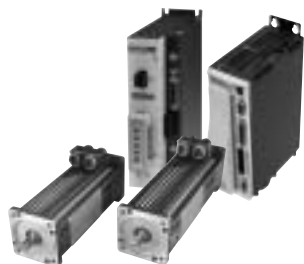

SYSTEM OVERVIEW

Kollmorgen GOLDLINE® B & SERVOSTAR CD 3 Systems

**Kollmorgen GOLDLINE® B SERIES MOTORS** SEE PAGE 38

Kollmorgen GOLDLINE series motors offer the widest range of solutions for servomotor applications. The interior permanent magnet design is the key to achieving high torque and power density while eliminating problems with magnets placed directly on the airgap. This magnetic structure allows low inertia designs making the Kollmorgen GOLDLINE series an industry standard for performance in high response, point-to-point move applications.

- Metric mounts
- 0.84 to 149 N-m continuous torque
- IP65 sealing
- Resolver feedback

Options:

- NEMA mountings
- IP67 sealing
- Multiple connector options
- Explosion proof designs
- Encoder feedback
- Gearmotors
- Electromechanical fail-safe brakes

When combined with the SERVOSTAR digital amplifier series (using Kollmorgen's patented phase angle advance algorithms), the system performance provides the most peak torque and speed in the industry. All motors and drives are UL recognized.

B-Series (Low-Inertia)

The B-Series provides extremely low inertia rotors allowing for optimum performance in applications requiring rapid acceleration and deceleration.

M-Series (Medium-Inertia)

The M-Series is an extension of the B-Series. With seven times higher inertia, this motor series offers the advantage of better performance for systems having compliant loads or larger inertia mismatches.

- 0.84 to 111 N-m (0.62 to 82 lb-ft) continuous torque
- 70.0 to 190.0 mm (2.76 to 7.48 inches) square frame
- Resolver feedback
- Maximum recommended speed 7500 rpm

EB-Series (Explosion-Proof)

Explosion-Proof Brushless servomotors are listed by UL for use in Class 1, Division 1, Groups C and D hazardous locations. This listing includes applications where vapors or gases form flammable or explosive environments.

The EB-Series has been tested and proven capable to withstand internal explosion without bursting or allowing ignition to reach outside the motor frame. Contact the Customer Support Group for more information.

- 0.84 to 111 N-m (0.62 to 82 lb-ft)
- 75.4 to 195.5 mm (2.97 to 7.70 inches) square frame
- Resolver feedback
- Maximum recommended speed 7500 rpm

Options

- Fail-safe brake
- NEMA mountings

BE-Series (Low-Inertia), ME-Series (Medium-Inertia)

The BE and ME Series provides the same inertia advantages as the B and M Series. A commutation encoder is incorporated in place of the resolver. The encoder provides Hall tracks as well as data channels A and A, B and B, I and I.

- 0.84 to 111 N-m (0.62 to 82 lb-ft)
- 70.0 to 190.0 mm (2.76 to 7.48 inches) square frame
- Encoder feedback
- Maximum recommended speed 6200 rpm
- 2048 LPR commutation encoder

Options

- Front mounted gearheads
- Fail-safe brake
- IP67 sealing
- NEMA mountings
- 1024 LPR commutation encoder

SERVOSTAR CD SERIES DRIVES SEE PAGE 28

The SERVOSTAR CD amplifier is a compact, fully digital amplifier designed to simplify installation and system set-up. Three control algorithms and self-tuning (to the load) functionality allows high performance operation to be achieved quickly and easily.

Since not one control algorithm is best for all machines, SERVOSTAR CD contains Pole Placement, PI, and PDFF control algorithms. SERVOSTAR CD utilizes the PC-based MOTIONLINK® for Windows® which automatically takes you through the key steps of installation and start up.

- 115 to 230 volt single phase or three phase AC input power
- Resolver Feedback Standard with Kollmorgen GOLDLINE Motors, encoder feedback supported for BE/ME Series Motors
- Integrate power supply
- Fully digital control

SERVOSTAR S SERIES DRIVES SEE PAGE 42

- 115 or 230 VAC Input Power (to PA Power Supply For Series)
- Resolver Feedback Standard with Kollmorgen GOLDLINE Motors, encoder feedback supported for BE/ME series motors
- Fully Digital Control

The SERVOSTAR amplifier is a compact, fully digital amplifier designed to simplify installation and system set-up. Three control algorithms and self-tuning (to the load) functionality allows high performance operation to be achieved quickly and easily.

Since not one control algorithm is best for all machines, SERVOSTAR contains Pole Placement, PI, and PDFF control algorithms. SERVOSTAR utilizes the PC-based MOTIONLINK for Windows® which automatically takes you through the key steps of installation and start up.

SYSTEM OVERVIEW

Kollmorgen GOLDLINE® B & SERVOSTAR® CD S systems
 Toll Free Phone: 877-378-0240
 Toll Free Fax: 877-378-0249
 sales@servo2go.com
 www.servo2go.com

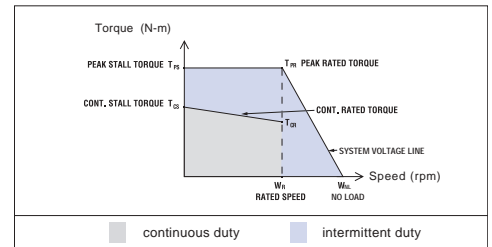

RECOMMENDED MOTOR/DRIVE SYSTEMS, 230 VAC

Servo Motor Model	Servo Drive Model	Peak Stall Torque T_{PS} N-m (lb-in)	Peak Rated Torque T_{PR} N-m (lb-in)	Cont. Stall Torque T_{CS} N-m (lb-in)	Cont. Rated Torque T_{CR} ^① N-m (lb-in)	Rated Speed W_R rpm	No-Load Speed W_{NL} rpm	Cont. Stall Current I_{CS} A_{RMS}	Current at Peak Torque I_{PS} A_{RMS}	Inertia ^④ J kgm ² (lb-in) ²	Inductance Line-Line L mH
B Series motors with SERVOSTAR® S, CD Drives											
B-102-A ②	CR03	2.41 (21.3)	1.15 (10.2)	0.84 (7.43)	0.69 (6.11)	7,500	n/a	2.4	7.2	0.000309 (0.000273)	30
B-104-A ②	CR03	4.38 (38.8)	1.89 (16.7)	1.55 (13.7)	1.51 (13.4)	5,600	n/a	3.0	9	0.000461 (0.000408)	28.1
B-104-B ②	CR06	4.45 (39.4)	2.40 (21.2)	1.57 (13.9)	1.42 (12.6)	7,500	n/a	4.2	12.6	0.000461 (0.000408)	14.4
B-106-A ②	CR03	6.10 (54.0)	3.50 (31.0)	2.20 (19.5)	2.00 (17.7)	4,200	n/a	3.0	9	0.0000765 (0.000677)	37.5
B-106-B ②	CR06	6.35 (56.2)	2.00 (17.7)	2.22 (19.6)	1.89 (16.7)	7,500	n/a	6.0	18	0.0000765 (0.000677)	9.4
B-202-A ②	CR03	7.45 (65.9)	2.70 (23.9)	2.25 (19.9)	2.25 (19.9)	2,500	n/a	1.7	6	0.0000996 (0.000882)	185
B-202-B ②	CR03	6.93 (61.3)	3.00 (26.6)	2.44 (21.6)	2.35 (20.8)	3,800	n/a	3.0	9	0.0000996 (0.000882)	68
B-202-C ②	CR03	7.65 (67.7)	3.10 (27.4)	2.44 (21.6)	2.29 (20.3)	6,200	n/a	5.0	9	0.0000996 (0.000882)	25
B-204-A ②	CR03	13.7 (121)	6.75 (59.7)	4.47 (39.6)	3.96 (35.0)	1,900	n/a	2.7	8.7	0.000173 (0.00153)	133
B-204-B ②	CR06	13.8 (122)	7.00 (62.0)	4.47 (39.6)	4.06 (35.9)	3,600	n/a	5.3	17.2	0.000173 (0.00153)	38
B-204-C ②	CR10	9.49 (84.0)	5.49 (48.6)	4.79 (42.4)	4.37 (38.7)	6,200	n/a	9.8	20	0.000173 (0.00153)	12
B-206-A ②	CR03	18.4 (163)	8.60 (76.1)	6.51 (57.6)	6.51 (57.6)	1,400	n/a	3.0	9	0.000251 (0.00222)	130
B-206-B ②	CR06	18.4 (163)	8.75 (77.4)	6.24 (55.2)	6.20 (54.9)	2,800	n/a	5.8	18	0.000251 (0.00222)	32
B-206-C ②	CR10	12.6 (112)	8.54 (75.6)	6.44 (57)	5.52 (48.9)	4,900	n/a	10	20	0.000251 (0.00222)	11
B-402-A ③	CR03	19.2 (170)	6.10 (54.0)	6.80 (60.2)	6.10 (54.0)	1,500	n/a	3.0	9	0.000323 (0.00286)	220
B-402-B ③	CR06	19.0 (168)	9.00 (79.7)	6.78 (60.0)	6.50 (57.5)	3,000	n/a	6.4	18	0.000323 (0.00286)	50
B-402-C ③	CR10	12.5 (111)	8.20 (72.6)	6.50 (57.5)	5.40 (47.8)	5,000	n/a	9.8	20	0.000323 (0.00286)	21
B-404-A ③	CR06	35.9 (318)	18.3 (162)	13.0 (115)	13.0 (115)	1,500	n/a	6.0	16.4	0.000656 (0.00581)	102
B-404-B ③	CR10	25.6 (227)	20.3 (180)	13.3 (118)	12.8 (113)	2,500	n/a	9.9	20	0.000656 (0.00581)	33.5
B-404-C ③	SR20	24.1 (213)	16.7 (148)	13.1 (116)	10.4 (92)	5,000	n/a	19.8	40	0.000656 (0.00581)	8.4
B-404-D ③	SR20	33.4 (296)	23.3 (206)	13.1 (116)	11.5 (102)	3,700	n/a	15	40	0.000656 (0.00581)	15
B-406-A ③	CR10	36.3 (321)	28.7 (254)	17.6 (156)	16.3 (144)	1,700	n/a	9.5	20	0.000929 (0.00822)	42
B-406-B ③	SR20	37.2 (329)	26.4 (234)	18.6 (165)	15.5 (137)	3,200	n/a	19.1	40	0.000929 (0.00822)	12
B-406-C ③	SR30	37.0 (327)	25.5 (226)	17.0 (150)	13.8 (122)	5,000	n/a	27.2	60	0.000929 (0.00822)	4.8
B-602-A ③	CR10	31.9 (282)	23.7 (210)	17.6 (156)	15.7 (139)	2,000	n/a	10	20	0.00103 (0.00912)	32
B-602-B ③	SR20	29.6 (262)	20.3 (180)	17.4 (154)	13.7 (121)	4,000	n/a	20	40	0.00103 (0.00912)	9
B-602-C ③	SR20	40.0 (354)	26.2 (232)	17.4 (154)	14.5 (128)	3,000	n/a	15	40	0.00103 (0.00912)	14
B-604-A ③	SR20	60.2 (533)	44.7 (396)	30.1 (266)	26.5 (235)	2,150	n/a	19	40	0.00203 (0.0180)	13.3
B-604-B ③	SR30	59.3 (525)	42.3 (374)	30.1 (266)	23.6 (209)	3,150	n/a	27.7	60	0.00203 (0.0180)	6.3
B-604-C ③	SR55	71.2 (630)	39.6 (350)	31.2 (276)	19 (168)	4,300	n/a	39.4	110	0.00203 (0.0180)	3.3
B-604-D ③	SR20	78.6 (696)	62.4 (552)	30.9 (273)	28.1 (249)	1,600	n/a	15	40	0.00203 (0.0180)	22
B-606-A ③	SR20	86.2 (763)	70.5 (624)	44.8 (397)	40.4 (358)	1,500	n/a	20	40	0.00304 (0.0269)	15.6
B-606-B ③	SR55	107 (951)	73.5 (651)	44.8 (397)	35.0 (310)	3,050	n/a	40	110	0.00304 (0.0269)	3.8
B-606-C ③	SR55	84.1 (744)	51.5 (456)	44.8 (397)	24.4 (216)	4,150	n/a	54.8	110	0.00304 (0.0269)	2.1
B-606-D ③	SR30	82.7 (732)	63.0 (558)	42.0 (372)	33.9 (300)	2,300	n/a	28	60	0.00304 (0.0269)	7
B-606-F ③	SR20	122 (1080)	94.9 (840)	44.8 (397)	42.0 (372)	1,100	n/a	14	40	0.00304 (0.0269)	32.5
B-802-A ③	SR30	90.8 (804)	71.3 (631)	42.0 (372)	37.7 (334)	2,000	n/a	24.9	60	0.00488 (0.0432)	16.3
B-802-B ③	SR55	103.4 (915)	68.9 (610)	40.7 (360)	35.3 (312)	2,750	n/a	32.4	110	0.00488 (0.0432)	9.4
B-804-A ③	SR55	201 (1779)	155 (1372)	78.6 (696)	68.9 (610)	1,500	n/a	35	110	0.00840 (0.0743)	13
B-804-B ③	SR55	144 (1275)	119 (1053)	78.6 (696)	66.2 (586)	2,000	n/a	48	110	0.00840 (0.0743)	7.2
B-804-C ③	SR85	172 (1522)	130 (1151)	78.6 (696)	50.0 (443)	3,000	n/a	70	170	0.00840 (0.0743)	3.2
B-806-A ③	SR55	214 (1894)	180 (1593)	109 (960)	94.0 (832)	1,550	n/a	49.1	110	0.0126 (0.112)	8
B-806-B ③	SR85	191 (1690)	122 (1080)	100 (885)	51.5 (456)	3,000	n/a	94	170	0.0126 (0.112)	2.1
B-806-C ③	SR30	201 (1779)	182 (1611)	109 (960)	96.3 (852)	900	n/a	30	60	0.0126 (0.112)	20
B-808-C ③	SR55	312 (2761)	217 (1921)	149 (1319)	145 (1283)	1,000	n/a	47.4	110	0.0168 (0.149)	8.05

Note: System data available for M series motors, EB series motors and for all motors at 115 VAC—see the MOTIONEERING® CD bound into the back inside cover of this catalog.

- ① Ambient temperature at 40°C (or less).
- ② Continuous duty ratings are with motor mounted to a 96 in² x 1/4" Aluminum faceplate.
- ③ Continuous duty ratings are with motor mounted to a 300 in² x 3/4" Aluminum faceplate.
- ④ Inertia includes feedback inertia.

B/M MOTORS

Kollmorgen GOLDLINE® B & SERVOSTAR® CD, 3 System Data

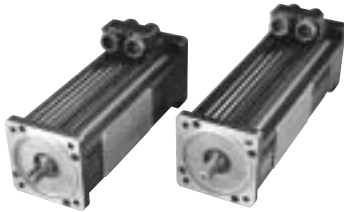

B/M-10x-x-24

mm (in)

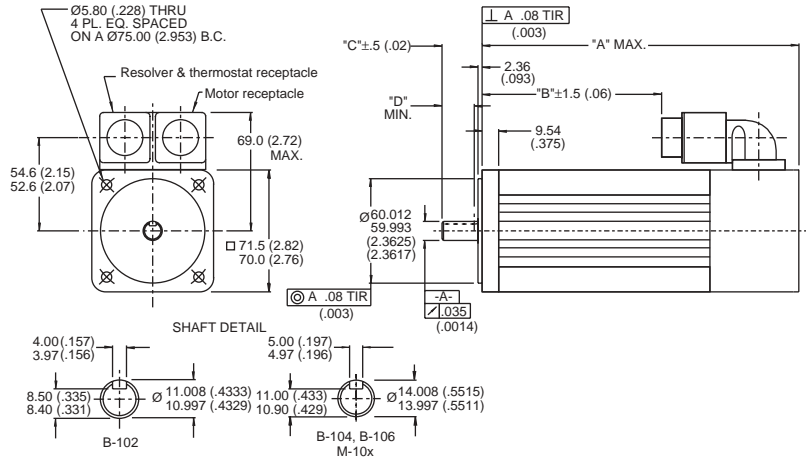

Features

B / M Series
Low / Medium Inertia

Compact (high torque/volume ratio)

Speeds to 7500 rpm standard

UL recognized

Rugged resolver feedback

Built-in thermostat

Rear shaft extension

Class H insulation

EB Series
Explosion Proof

Compact (high torque/volume ratio)

Speeds to 7500 rpm standard

UL recognized

Rugged resolver feedback

Built-in thermostat

Class H insulation

BE / ME Series
Low / Medium Inertia

Compact (high torque/volume ratio)

Speeds to 6000 rpm standard

UL recognized

Communication encoder feedback (2048 LPR)

Built-in thermostat

Class H insulation

B/M-20x-x-23

mm (in)

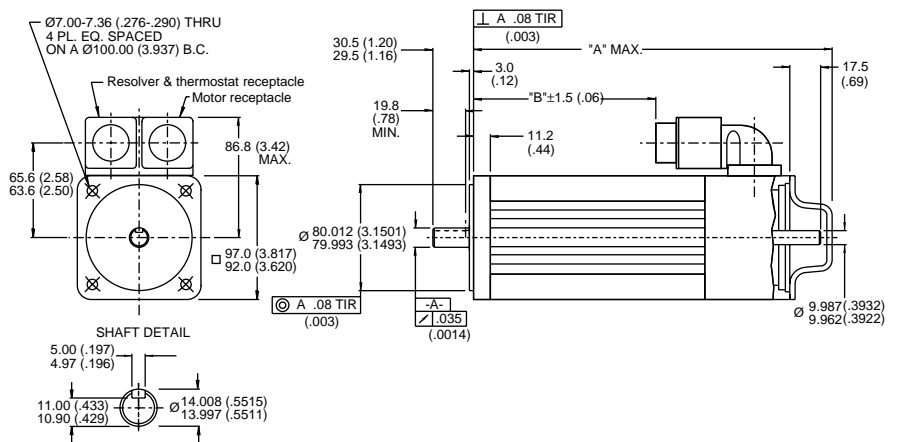

B/M 40X & 60X SERIES MOTORS

PARAMETER	SYMBOL	UNITS	B-404-A BE-404-A M-405-A ME-405-A EB-404-A	B-404-B BE-404-B M-405-B ME-405-B EB-404-B	B-404-C BE-404-C M-405-C ME-405-C EB-404-C	B-404-D BE-404-D M-407-A ME-407-D EB-404-D	B-406-A BE-406-A M-407-B ME-407-A EB-406-A	B-406-B BE-406-B M-407-B ME-407-B EB-406-B	B-406-C BE-406-C M-407-C ME-407-C EB-406-C	B-602-A BE-602-A M-603-A ME-603-A EB-602-A	B-602-B BE-602-B M-603-B ME-603-B EB-602-B
Horsepower	HP _{rated}	hp	2.7	4.5	7.3	6.0	3.9	7.4	9.6	4.4	7.7
Kilowatts	kW _{rated}	kW	2.0	3.4	5.4	4.5	2.9	5.5	7.2	3.3	5.7
Speed at Rated Power	N _{rated}	rpm	1500	2500	5000	3700	1700	3200	5000	2000	4000
Max Operating Speed	N _{max}	rpm	1500	2500	5000	3700	1700	3200	5000	2000	4000
Cont. Torque (Stall) at 40°C	T _{CS}	N-m (lb-ft)	13.0 (9.6)	13.3 (9.8)	13.1 (9.7)	13.1 (9.7)	17.6 (13.0)	18.6 (13.7)	17 (12.5)	17.6 (13.0)	17.4 (12.8)
Cont. Torque (Stall) at 25°C	T _{CS}	N-m (lb-ft)	13.8 (10.2)	14.1 (10.4)	13.9 (10.3)	14 (10.3)	18.7 (13.8)	19.7 (14.5)	18 (13.3)	18.7 (13.8)	18.4 (13.6)
Cont. Line Current	I _{CS}	A _{RMS}	6.0	9.9	19.8	15.0	9.5	19.1	27.2	10.0	20.0
Peak Torque	T _{PS}	N-m (lb-ft)	35.9 (26.5)	36.6 (27.0)	35.3 (26)	37.5 (27.6)	48.5 (35.8)	49.5 (36.5)	48.3 (35.6)	51.2 (37.7)	49.8 (36.7)
Peak Line Current	I _{PS}	A _{RMS}	16.4	28.8	55.9	45	27.3	53.3	81.4	30.5	61.4
Max Theoretical Acceleration (B, BE, EB-60/60x) (M, ME-40/60x)	Z	rad/sec ²	54800 8150	55800 8310	53700 8000	57000 8490	52300 7380	53300 7530	52000 7340	49700 6590	48400 6420
Torque Sensitivity (Stall) ±10%	K _t	N-m (lb-ft)/A _{RMS}	2.31 (1.70)	1.34 (0.99)	0.66 (0.49)	0.877 (0.647)	1.87 (1.38)	0.98 (0.72)	0.63 (0.46)	1.77 (1.30)	0.85 (0.63)
Back EMF (Line to Line) ±10%	K _b	V _{RMS} / krpm	139	81.2	40.2	53	113	37.7	40.7	107	51.6
Max Line-to-Line volts	V _{max}	V _{RMS}	250	250	250	250	250	250	250	250	250
DC Res at 25°C (Line-to-Line) ±10%	R _m	ohms	4.1	1.32	0.34	0.63	1.7	0.44	0.20	1.55	0.382
Inductance (Line-to-Line) ±30%	L _m	mH	102	33.5	8.4	15.0	42	12	4.8	32	9
Rotor Inertia (B, BE, EB-60/60x) (M, ME-40/60x)	J _m	kg-m ² lb-ft-sec ²	0.000656-0.000484 0.00441-0.00325	0.000656-0.000484 0.00441-0.00325	0.000656-0.000484 0.00441-0.00325	0.000656-0.000484 0.00441-0.00325	0.000929-0.000685 0.00657-0.00485	0.000929-0.000685 0.00657-0.00485	0.000929-0.000685 0.00657-0.00485	0.001028-0.000758 0.00775-0.00572	0.001028-0.000758 0.00775-0.00572
Weight (B, BE-40/60x) (M, ME-40/60x) (EB-40/60x)	W _t	kg (lb)	12.5 (27.5) 15.5 (34) 12.5 (27)	12.5 (27.5) 15.5 (34) 12.5 (27)	12.5 (27.5) 15.5 (34) 12.5 (27)	12.5 (27.5) 15.5 (34) 12.5 (27)	15.9 (35) 20 (44) 21.5 (47.6)	15.9 (35) 20 (44) 21.5 (47.6)	15.9 (35.0) 20 (44) 21.5 (47.6)	16.8 (37) 20 (44) 16.8 (37)	16.8 (37) 20 (44) 16.8 (37)
Static Friction	T _f	N-m (lb-ft)	0.26 (0.19)	0.26 (0.19)	0.26 (0.19)	0.26 (0.19)	0.287 (0.212)	0.287 (0.212)	0.287 (0.212)	0.49 (0.36)	0.49 (0.36)
Thermal Time Constant (B, BE, M, ME-40/60x)-(EB-40/60x)	TCT	minutes	25-9	25-9	25-9	25-9	28-12	28-12	28-12	28-12	28-12
Viscous Damping Z Source	F _i	N-m (lb-ft)/krpm	0.018 (0.013)	0.018 (0.013)	0.018 (0.013)	0.018 (0.013)	0.020 (0.015)	0.020 (0.015)	0.020 (0.015)	0.072 (0.053)	0.072 (0.053)
Motor Constant at 25°C	K _m	N-m (lb-ft)/watts	0.926 (0.683)	1.01 (0.746)	0.982 (0.724)	0.952 (0.702)	1.23 (907)	1.27 (0.937)	1.21 (0.892)	1.22 (0.903)	1.22 (0.898)
Thermal Resistance at Stall	R _{th}	°C/watt	0.35	0.40	0.38	0.36	0.32	0.32	0.32	0.33	0.33
Number of Poles			4	4	4	4	4	4	4	6	6

B/M 60X & 80X SERIES MOTORS

PARAMETER	SYMBOL	UNITS	B-602-C BE-602-C M-603-C ME-603-C EB-602-C	B-604-A BE-604-A M-605-A ME-605-A EB-604-A	B-604-B BE-604-B M-605-B ME-605-B EB-604-B	B-604-C BE-604-C M-605-C ME-605-C EB-604-C	B-606-A BE-606-A M-607-A ME-607-A EB-606-A	B-606-B BE-606-B M-607-B ME-607-B EB-606-B	B-606-C BE-606-C M-607-C ME-607-C EB-606-C	B-802-A BE-802-A M-803-D ME-803-D EB-802-D	
Horsepower	HP _{rated}	hp	6.1	8.0	10.4	11.5	8.8	15	14.2	11	10.6
Kilowatts	kW _{rated}	kW	4.6	6.0	7.7	8.6	6.6	11.2	10.6	8.2	7.9
Speed at Rated Power	N _{rated}	rpm	3000	2150	3150	4300	1550	3050	4150	2300	2000
Max Operating Speed	N _{max}	rpm	3000	2150	3150	4300	1550	3050	4150	2300	2000
Cont. Torque (Stall) at 40°C	T _{CS}	N-m (lb-ft)	17.4 (12.8)	30.1 (22.2)	30.1 (22.2)	31.2 (23)	44.8 (33.0)	42 (31)	44.8 (33)	42 (31)	42 (31)
Cont. Torque (Stall) at 25°C	T _{CS}	N-m (lb-ft)	18.4 (13.6)	31.9 (23.5)	31.8 (23.5)	33.6 (24.4)	45.5 (35.0)	44.6 (32.9)	47.5 (35)	44.6 (32.9)	44.6 (32.9)
Cont. Line Current	I _{CS}	A _{RMS}	15.0	19.0	27.7	39.4	20.0	37.5	54.8	28	24.9
Peak Torque	T _{PS}	N-m (lb-ft)	49.5 (36.5)	86.4 (63.7)	87.7 (64.7)	86.4 (63.7)	132 (97.2)	126 (93)	124 (91.6)	123 (90.4)	130 (96)
Peak Line Current	I _{PS}	A _{RMS}	45	57.4	84.8	118.6	62	118.6	160	86.2	81
Max Theoretical Acceleration (B, BE, EB-60/80x) (M, ME-60/80x)	Z	rad/sec ²	48400 6420	42500 6140	43100 6240	42500 6140	43400 6220	41500 5960	40900 5870	40400 5790	26700 3710
Torque Sensitivity (Stall) ±10%	K _t	N-m (lb-ft)/A _{RMS}	1.15 (0.85)	1.59 (1.17)	1.09 (0.80)	0.79 (0.58)	2.24 (1.65)	1.12 (0.83)	0.82 (0.60)	1.2 (1.1)	1.69 (1.15)
Back EMF (Line to Line) ±10%	K _b	V _{RMS} / krpm	70	95.8	65.9	47.9	135.0	67.7	49.5	90.5	102
Max Line-to-Line volts	V _{max}	V _{RMS}	250	250	250	250	250	250	250	250	250
DC Res at 25°C (Line-to-Line) ±10%	R _m	ohms	674	0.508	0.234	0.126	0.500	0.140	0.076	0.26	0.361
Inductance (Line-to-Line) ±30%	L _m	mH	14	13.3	6.3	3.3	15.6	3.8	2.1	17.0	16.3
Rotor Inertia (B, BE, EB-60/80x) (M, ME-60/80x)	J _m	kg-m ² lb-ft-sec ²	0.001028-0.000758 0.00775-0.00572	0.002034-0.001500 0.01406-0.01037	0.002034-0.001500 0.01406-0.01037	0.002034-0.001500 0.01406-0.01037	0.00304-0.00224 0.02117-0.01561	0.00304-0.00224 0.02117-0.01561	0.00304-0.00224 0.02117-0.01561	0.00304-0.00224 0.02117-0.01561	0.00488-0.00360 0.0352-0.0259
Weight (B, BE-60/80x) (M, ME-60/80x) (EB-60/80x)	W _t	kg (lb)	16.8 (37) 20 (44) 16.8 (37)	23.1 (51) 28.7 (63) 23.1 (51)	23.1 (51) 28.7 (63) 23.1 (51)	23.1 (51) 28.7 (63) 23.1 (51)	29.9 (66) 37.8 (83) 29.9 (66)	29.9 (66) 37.8 (83) 29.9 (66)	29.9 (66) 37.8 (83) 29.9 (66)	29.9 (66) 37.8 (83) 29.9 (66)	36 (79) 43.7 (96) 36 (79)
Static Friction	T _f	N-m (lb-ft)	0.49 (0.36)	0.52 (0.38)	0.52 (0.38)	0.52 (0.38)	0.941 (0.694)	0.941 (0.694)	0.941 (0.694)	0.941 (0.694)	0.64 (0.47)
Thermal Time Constant (B, BE, M, ME-60/80x)-(EB-60/80x)	TCT	minutes	28-12	33-14	33-14	33-14	38-16	38-16	38-16	38-16	40-0.60
Viscous Damping Z Source	F _i	N-m (lb-ft)/krpm	0.072 (0.053)	0.109 (0.080)	0.109 (0.080)	0.109 (0.080)	0.147 (0.108)	0.147 (0.108)	0.147 (0.108)	0.147 (0.108)	0.237-0.175
Motor Constant at 25°C	K _m	N-m (lb-ft)/watts	1.22 (0.902)	1.92 (1.43)	1.94 (1.43)	1.93 (1.42)	2.74 (2.02)	2.59 (1.91)	2.57 (1.88)	2.55 (1.88)	2.43-1.79
Thermal Resistance at Stall	R _{th}	°C/watt	0.34	0.28	0.28	0.26	0.26	0.26	0.22	0.25	0.23
Number of Poles			6	6	6	6	6	6	6	6	6

B/M 80X SERIES MOTORS

PARAMETER	SYMBOL	UNITS	B-802-B BE-802-B M-803-B ME-803-B EB-802-B	B-802-C BE-802-C M-803-C ME-803-C EB-802-C	B-804-A BE-804-A M-805-A ME-805-A EB-804-A	B-804-B BE-804-B M-805-B ME-805-B EB-804-B	B-804-C BE-804-C M-805-C ME-805-C EB-804-C	B-806-A BE-806-A M-807-A ME-807-A EB-806-A	B-806-B BE-806-B M-807-B ME-807-B EB-806-B	B-806-C BE-806-C M-807-C ME-807-C EB-806-C	B-808-C
Horsepower	HP _{rated}	hp	13.6	8.2	14.5	18.6	21.0	20.5	21.7	12.2	20.3
Kilowatts	kW _{rated}	kW	10.1	6.1	10.8	13.9	15.7	15.3	16.2	9.1	15.1
Speed at Rated Power	N _{rated}	rpm	2750	1600	1500	2000	3000	1550	3000	900	1000
Max Operating Speed	N _{max}	rpm	2750	1600	1500	2000	3000	1550	3000	900	1000
Cont. Torque (Stall) at 40°C	T _{CS}	N-m (lb-ft)	40.7 (30)	40.7 (30)	78.6 (50)	78.6 (50)	78.6 (50)	109 (80)	111 (82)	109 (80)	149 (110)
Cont. Torque (Stall) at 25°C	T _{CS}	N-m (lb-ft)	43.1 (31.8)	43.1 (31.8)	83.4 (61.5)	83.4 (61.5)	83.4 (61.5)	115 (84.8)	117.9 (86.9)	115 (84.8)	158 (117)
Cont. Line Current	I _{CS}	A _{RMS}	32.4	18.9	35	48	70	49	94	30	47.4
Peak Torque	T _{PS}	N-m (lb-ft)	129 (95.3)	129 (95.3)	232 (171)	230 (170)	232 (171)	323 (238)	327 (241)	362 (267)	422 (311)
Peak Line Current	I _{PS}	A _{RMS}	108	60	109	147	217	154	291	100	134
Max Theoretical Acceleration (B, BE, EB-80x) (M, ME-80x)	Z	rad/sec ²	26500 3680	26500 3680	27600 3870	27400 3850	25600 3630	25900 3680	25900 3680	28700 4080	2510 n/a
Torque Sensitivity (Stall) ±10%	K _t	N-m (lb-ft)/A _{RMS}	1.26 (0.93)	2.16 (1.59)	2.25 (1.66)	1.65 (1.21)	1.13 (0.83)	2.21 (1.63)	1.18 (0.87)	3.62 (2.67)	3.15 (2.32)
Back EMF (Line to Line) ±10%	K _b	V _{RMS} / krpm	76	134	136	99.6	68.1	71.6	219	191	191
Max Line-to-Line volts	V _{max}	V _{RMS}	250	250	250	250	250	250	250	250	250
DC Res at 25°C (Line-to-Line) ±10%	R _m	ohms	0.200	0.568	0.230	0.129	0.508	0.130	0.034	0.340	0.168
Inductance (Line-to-Line) ±30%	L _m	mH	9.4	25.7	13	7.2	3.2	8.0	2.1	20	8.05
Rotor Inertia (B, BE, EB-80x) (M, ME-80x)	J _m	kg-m ² lb-ft-sec ²	0.00488-0.00360 0.0352-0.0259	0.00488-0.00360 0.0352-0.0259	0.00840-0.00620 0.05990-0.04415	0.00840-0.00620 0.05990-0.04415	0.00840-0.00620 0.05990-0.04415	0.0126-0.0093 0.0888-0.0655	0.0126-0.0093 0.0888-0.0655	0.0126-0.0093 0.0888-0.0655	0.0168-0.0124 0.0168-0.0124
Weight (B, BE-80x) (M, ME-80x) (EB-80x)	W _t	kg (lb)	36 (79) 43.7 (96) 36 (79)	36 (79) 43.7 (96) 36 (79)	50.6 (112) 62.8 (138) 50.6 (112)	50.6 (112) 62.8 (138) 50.6 (112)	50.6 (112) 62.8 (138)				

SERVOSTAR® S DRIVES

Kollmorgen GOLDLINE® B & SERVOSTAR® S System Data



SERVOSTAR® S FEATURES

Servo Control

- Advanced sinewave commutation technology provides smooth, precise low-speed control and high-speed performance
- Accurate torque control due to precision balanced current loops with closed loop sensors
- Velocity loop bandwidths to 400 Hz
- Self-tuning to the load
- Patented torque angle control that enhances motor performance
- Fully digital control loops
- Compact and attractive rugged metal package for space-saving, modern appearance - metal package minimizes electrical noise emission and susceptibility
- Pole Placement, PI, and PDFF control options
- Command modes: Torque (analog or serial); Velocity (analog or serial); Position (analog, serial, stored or pulse)
- Seven current ratings: 3, 6, 10, 20, 30, 55, and 85 amps RMS/phase continuous
- 2 to 1 peak/continuous current rating
- Run time counter

Easy Connectivity

- Built in encoder equivalent output which can eliminate the need for an additional position feedback device
- RS-232 or RS-485 Communication
- Unique multi-drop configuration allows a PC or PLC to communicate to multiple SERVOSTAR amplifiers via single RS-232 connection
- SERVOSTAR's versatile communication capabilities make it easy to integrate machine control data directly from the factory floor to your information system
- Analog ± 10 V, pulse/direction, master encoder, serial port command options

Robust Design

- Excellent protection against miswired connection on 24 volt I/O
- ESD rugged circuit design and fully metallic enclosure
- Self-protecting intelligent power modules
- Full protection against short circuit, overvoltage, undervoltage, heatsink overtemperature, motor overtemperature, overspeed, overcurrent, and feedback loss
- UL and cUL listed, CE approval
- Flash memory

Windows® Start-up Environment – MOTIONLINK®

- Advanced motion "wizard" automatically walks you through set-up
- PC "Oscilloscope" for measuring real-time motion performance

PA Series Power Supply

- PTC resistive soft-start technology eliminates nuisance tripping of fuses or breakers
- Six power supply options for optimal configuration of single and multi-axis systems
- Up to four amplifier axis can be used with one PA power supply, up to six with PA-LM logic only power supply
- Separate inputs for logic and bus voltages allow communications to SERVOSTAR without the bus power applied (PA14, PA28, PA50, PA75 and PA85 models)

Note:

Information on the required PA Series power supply may be found on the MOTIONEERING® CD-ROM bound into the inside back cover of this catalog, or visit our website at www.DanaherMotion.com.

SERVOSTAR® S DRIVES

Kollmorgen GOLDLINE® B & SERVOSTAR® System Data

AMPLIFIER SPECIFICATIONS

Electrical characteristics

- Closed loop velocity bandwidth up to 400 Hz
- Motor current ripple frequency:
 - 32 kHz (3/6/10 amp models)
 - 16 kHz (20/30/55/85 amp models)
- Analog command: 14 bit resolution
- Long term speed regulation (0.01%)
- Position loop update rate 500 µsec (2 kHz)
- Velocity loop update rate 250 µsec (4 kHz)
- Commutation update rate 62.5 µsec (16 kHz) (for smooth sinusoidal commutation)
- Current loop update rate 62.5 µs (16 kHz)

Fault protection

- Output phase to phase short circuit protection
- Overvoltage
- Undervoltage
- Overtemperature (motor and amplifier)
- Overspeed
- Overcurrent
- Feedback loss
- Foldback
- Supply loss
- Excessive position error

Environmental

- Operation range
 - Ambient 0 to 45°C (derated above ambient)
 - Storage -20°C to 70°C
- Humidity (non-condensing) 10% to 90%

Digital Compensation

- Velocity loop: PI, PDFF or Pole Placement selectable algorithms
- Factory preset or field tunable
- MOTIONLINK software provides tuning programming via RS-232 or RS-485 serial interface
- Position loop gain adjustment
- Digital current loop
- Adjustable filters

Inputs

- Analog command: ±10 V bit resolution up to 16,000 to 1 dynamic speed range
- Remote enable: 24 V
- Three multi-purpose inputs: 24 V Configurable to: CW limit switch, CCW limit switch, gear enable, start motion, second current limit, change velocity to torque mode, home switch, search for home, move to home registration capture, active disable, control fault relay, hold position plus using two inputs, up to four stored indexes or speeds can be executed
- Pulse command: up/down, pulse/direction, pulse or quadrature encoder format into RS-485 receivers or opto isolators

Communications

- RS-232 or RS-485 serial interface up to 19.2 kb

Outputs

- Fault: contact closure rated for 1 amp, 24 volt
- One multi-purpose output 24 V configuration: speed exceeded, current exceeded, amplifier in foldback, brake enable, motion complete, in position, zero speed detect

Operational Modes

- Torque control – from analog or serial command
- Velocity control –from analog or serial command

- Pulse following
- Gearing from quad encoder input
- Position control from analog or serial command

Diagnostics

- Seven segment LED display
- Error history log
- Internal variable monitoring
- DC scope

Motor Feedback

- Resolver: sine/cosine 2 V peak to peak (SERVOSTAR provides 4.25 V peak to peak for resolver excitation)
- Encoder: 5 V quadrature with or without Halls, with or without marker
- Absolute Sine Encoder: HEIDENHAIN EnDat™ Format

AMPLIFIER RATINGS

Model	Sx03	Sx06	Sx10	Sx20	Sx30	Sx55	Sx85
Output Continuous Current Per Phase (RMS/phase)	3	6	10	20	30	55	85
Output Peak Current Per Phase (RMS/phase) (2 sec.)	6	12	20	40	60	110	170
Output (kW) Continuous Power	1.1	2.2	3.6	7.2	11	20	33.8
Internal Power Dissipation (watts)	37	84	120	240	254	465	675
DC Bus Voltage Input (VDC) ①	110-360	110-360	110-360	260-360	260-360	260-360	260-360
PWM Switching Frequency (kHz)	16	16	16	8	8	8	8

Notes:

- ① DC input voltage is supplied by a separate PA series power supply. for information about models and ratings of these supplies, see the MOTIONEERING® CD-ROM bound into the inside back cover of this catalog, or visit our website at www.DanaherMotion.com.

Sx03/06/10/20/30/55/85 AMPLIFIER

mm (in)

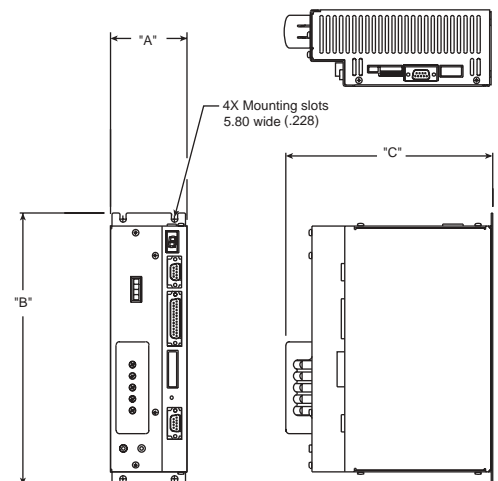

MODEL	DIM "A"	DIM "B"	DIM "C"
Sx03	75 (2.95)	264 (10.39)	202 (7.95)
Sx06	75 (2.95)	264 (10.39)	202 (7.95)
Sx10	90 (3.54)	264 (10.39)	202 (7.95)
Sx20	118.6 (4.67)	264 (10.39)	202 (7.95)
Sx30	142 (5.59)	264 (10.39)	210 (8.27)
Sx55	160 (6.3)	302 (11.89)	211 (8.30)
Sx85	184.7 (7.27)	302 (11.89)	218.8 (8.61)

SERVOSTAR® CD DRIVES

Kollmorgen GOLDLINE® XT & SERVOSTAR CD System



SERVOSTAR® CD FEATURES

Servo Control

- Advanced patented sinewave commutation technology provides smooth, precise low-speed control and high-speed performance
- Accurate torque control due to precision balanced current loops with closed loop sensors
- Velocity loop bandwidths to 400 Hz
- Self-tuning to the load
- S-curve acceleration feature for reducing acceleration "jerk" and machine wear
- Patented torque angle control enhances motor performance
- Fully digital control loops
- Compact and attractive rugged metal package for space-saving, modern appearance - metal package minimizes electrical noise emission and susceptibility
- Pole Placement, PI, and PDFF control options
- Low Pass or Notch Filters for compliant & resonant machines
- Command modes: Torque (analog or serial); Velocity (analog or serial); Position (analog, serial, stored or pulse)
- Three current ratings: 3/9, 6/18 & 10/20 amp RMS/phase continuous/peak current
- 3 to 1 peak/continuous current rating (2 to 1 on 10 amp product)

Analog Command:

- 14 Bit analog conversion
- Simple absolute & incremental moves thru internal profile generator

Easy Connectivity

- Built in encoder equivalent output can eliminate the need for an additional position feedback device
- RS232 or RS485 Communication
- Unique multi-drop configuration allows a PC or PLC to communicate to multiple SERVOSTAR CD amplifiers via single RS-232 connection
- SERVOSTAR CD's versatile communication capabilities make it easy to integrate machine control data directly from the factory floor to your information system
- Analog ± 10 V, pulse/direction, master encoder, serial port, command options
- SERCOS interface™

Robust Design

- Protection against miswired connection on 24 volt I/O
- ESD rugged circuit design and fully metallic enclosure
- Self-protecting intelligent power modules
- Full protection against short circuit, overvoltage, undervoltage, heatsink overtemperature, motor overtemperature, overspeed, overcurrent, and feedback loss
- UL , cUL listed, and CE
- Flash memory

Windows® Start-up Environment – MOTIONLINK®

- Advanced motion "wizard" automatically walks you through set-up
- Auto configuration function checks for correct wiring of motor and feedback
- PC "Oscilloscope" for measuring real-time motion performance

Motion Indexing

- Stores up to 4 motion profiles in memory
- Start motion through serial command or digital I/O
- Homing functions

Configurable I/O

- 3 digital inputs, 1 digital output, & 1 analog output can be configured to a variety of functions to customize the SERVOSTAR CD to individual machines

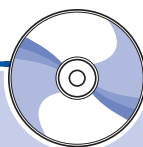

MOTIONEERING® CD-ROM

For more detailed product and selection information, see the **MOTIONEERING** CD-ROM inside the back cover of this catalog or visit our website at www.servo2go.com

SERVOSTAR® CD DRIVES

Kollmorgen GOLDLINE® XT & SERVOSTAR CD System

AMPLIFIER SPECIFICATIONS

Electrical characteristics

- Closed loop velocity bandwidth up to 400 Hz
- Motor current ripple frequency (16-32 kHz)
- Long term speed regulation (0.01%)
- Position loop update rate 500 μ s (2 kHz)
- Velocity loop update rate 250 μ s (4 kHz)
- Commutation update rate 62.5 μ s (16 kHz)
- Current loop update rate 62.5 μ s (16 kHz)

Fault protection

- Output phase to phase short circuit protection
- Overvoltage
- Undervoltage
- Overtemperature (motor and amplifier)
- Overspeed
- Overcurrent
- Feedback loss
- Foldback
- Supply loss
- Excessive position error

Environmental

- Operation range
 - Ambient 5 to 45°C
 - Storage -20°C to 70°C
- Humidity (non-condensing) 10% to 90%

Velocity Loop Compensation

- Vel: PI, PDFF or Pole Placement selectable algorithms
- Factory preset or field tunable
- **MOTIONLINK** software provides tuning programming via RS-232 or RS-485 serial interface
- Adjustable filters

Position Loop Compensation

- PID

Operational modes

- Torque control — from analog or serial command
- Velocity control — from analog or serial command
- Pulse following/Up-Down count
- Gearing from quad encoder input
- Position control

Inputs

- Analog command: ± 10 V
- Remote enable: 24 V
- Three multi-purpose 24 V inputs configurable to: CW limit switch, CCW limit switch, gear enable, start motion, second current limit, change velocity to torque mode, home switch, search for home, move to home registration capture, active disable, control fault relay, hold position plus using two inputs, up to four stored indexes or speeds can be executed
- Pulse command: up/down, pulse/direction, pulse or quadrature encoder format into RS-485 receivers or opto isolators

Communications

- RS-232 or RS-48S serial interface 9600 or 19.2 kb
- Drive-to-Drive multidrop
- SERCOS interface™

Outputs

- Fault: contact closure rated for 1 amp, 24 volt
- One multi-purpose 24 V output configurable to: speed exceeded, current exceeded, amplifier in foldback, brake enable, motion complete, in position, zero speed detect, encoder INIT complete
- ± 10 V, 12-bit analog output, configurable, for monitoring of various parameters

Diagnostics

- Seven segment LED display
- Error history log
- Internal variable monitoring
- PC scope

Motor Feedback

- Resolver, Incremental Encoder, Sine Encoder (including HEIDENHAIN EnDat™ support) or halls-only operation
- Auxiliary encoder feedback, used for Dual Loop or Master/Slave Operation.
- Commutation initialization with minimal motion

AMPLIFIER RATINGS

Model	Cx03	Cx06	Cx10
Output Continuous Current Per Phase (RMS/phase)	3	6	10
Output Peak Current Per Phase (1/2 sec)	9	18	20
Rated Output Continuous Power (kW)	1.1	2.2	3.5
Internal Power Dissipation (watts)	60	80	132
PWM Switching Frequency (kHz)	16	8	8
AC Input Line Voltage (V) (1 phase)	115-230	115-230	230, 3 phase
Rated Input Power (kW)	1.7	2.8	4.6

SERVOSTAR CD Cx03/06/10

mm (in)

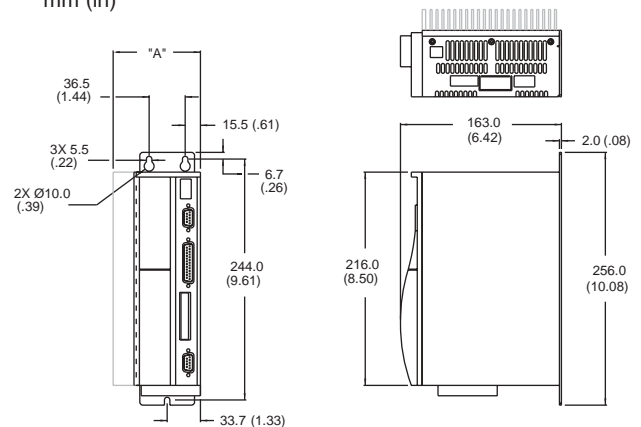

MODEL	SIZE (amp)	DIM. "A"
Cx03	3	67.4 (2.65)
Cx06	6	88.4 (3.48)
Cx10	10	99.1 (3.90)