

- High Thrust, High Speed, High Responsiveness, High Precision, Long Stroke
- Simple Design and Easy Installation
- Non-Contact Drive means Low Noise, Long Lifespan, and Maintenance-Free

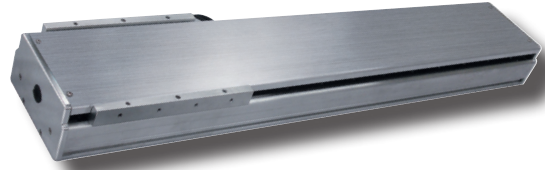

Stage Specifications

Rated Spec	Unit	Specification
Encoder Resolution	µm	1 (HEIDENHAIN LIDA279)
Continuous Force	N	185
Acceleration Force ¹	N	970
Continuous Current ²	A	2.7
Acceleration Current ¹	A	14.4
Force Constant (Kf)	N/A rms	68
Back-EMF Constant	V/m/s	22
Resistance ³	ohm	7.2
Inductance ³	mH	12
Magnetic Pitch (N-N)	mm	120
Maximum Acceleration ⁴	G	3.5
Maximum Velocity ^{4, 5}	m/s	3
Bi-Directional Repeatability	mm	±0.0005
Max Load, Horizontal	kg	60
Load Capacity	kg	30
Stroke, Single Forcer ⁶	mm	300-2000 (100 interval)
Stroke, Double Forcer ⁶	mm	300-1700 (100 interval)
Operating Temperature	°C	0~+40
Operating Humidity	%	20~80 (no condensation)
Storage Temperature	°C	-20~+60
Moving Mass	kg	4.4

Overhanging Weight Tolerance (mm)

	Load	0°	45°	90°
Horizontal	10kg	1000	1000	1000
	20kg	1000	900	1000
	30kg	940	780	1000
	40kg	840	660	1000
	50kg	750	590	950
	60kg	680	540	900
Wall	5kg	1000	1000	700
	10kg	1000	900	600
	15kg	1000	810	520
	20kg	1000	710	430
	25kg	980	620	350
	30kg	890	530	300

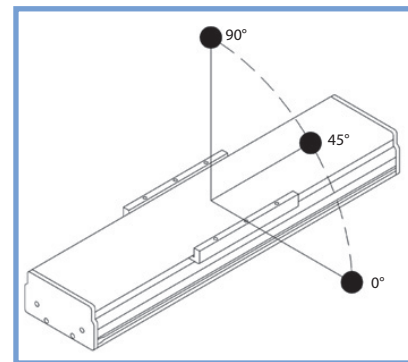

Note 1: Acceleration Force given is based on the output with the use of the following driver - SLP35: (14) Hitachi Production Machine System ADA3-01LL2
 Note 2: The effective amperage when the temperature increase of the coil front becomes 110K.
 Note 3: An average value of U-V, U-W, and V-W.
 Note 4: There are instances when this is not achieved due to load or operation specifications.
 Note 5: There are instances when this is not achieved due to the length of the stroke.
 Note 6: Contact NPA for longer stroke lengths.

Pin	Signal	Wire Color	Function
1	A+	White	Incremental Signal
2	0V	Black/Red	Ground
3	B+	Green	Incremental Signal
4	5V	Red	Power
7	Z-	Black/Yellow	Reference Mark
9	A-	Black/White	Incremental Signal
11	B-	Black/Green	Incremental Signal
14	Z+	Yellow	Reference Mark

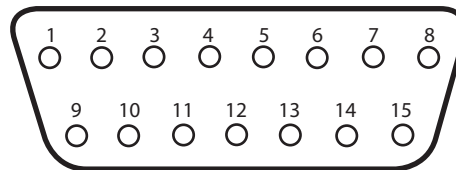

F-V Curve

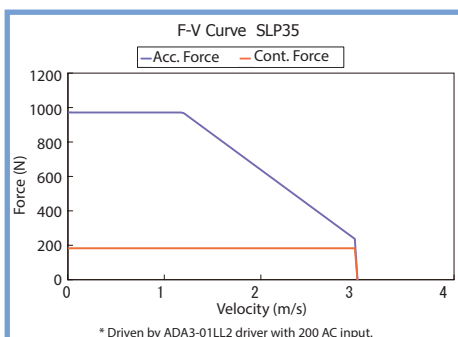

Max. Acceleration vs. Load

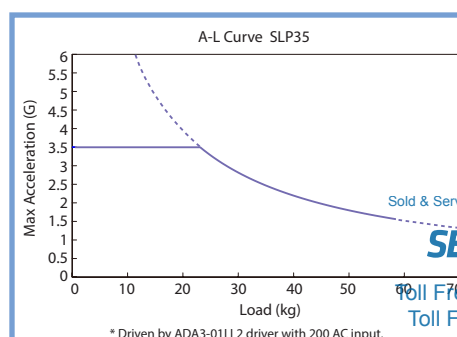

Position Repeatability

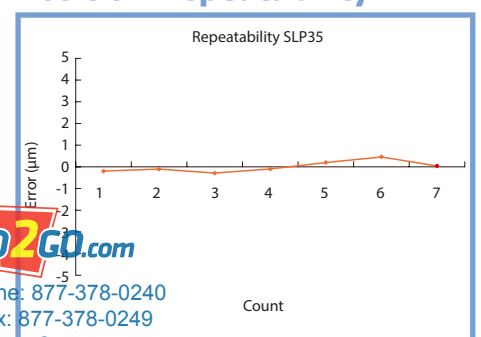

Sold & Serviced By:
SERVO2GO.com
 Toll Free Phone: 877-378-0240
 Toll Free Fax: 877-378-0249
 sales@servo2go.com
 www.servo2go.com

Single Slider Dimensions

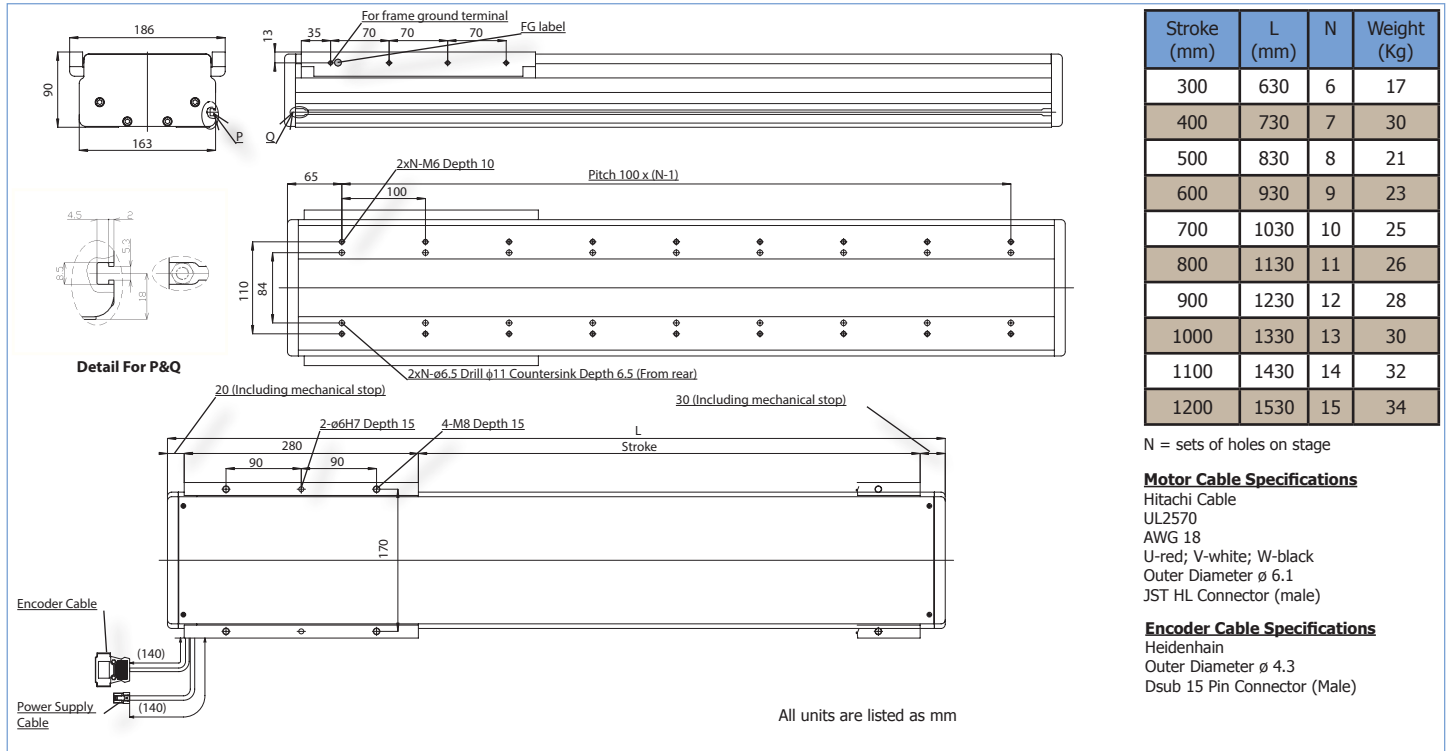

Double Slider Dimensions

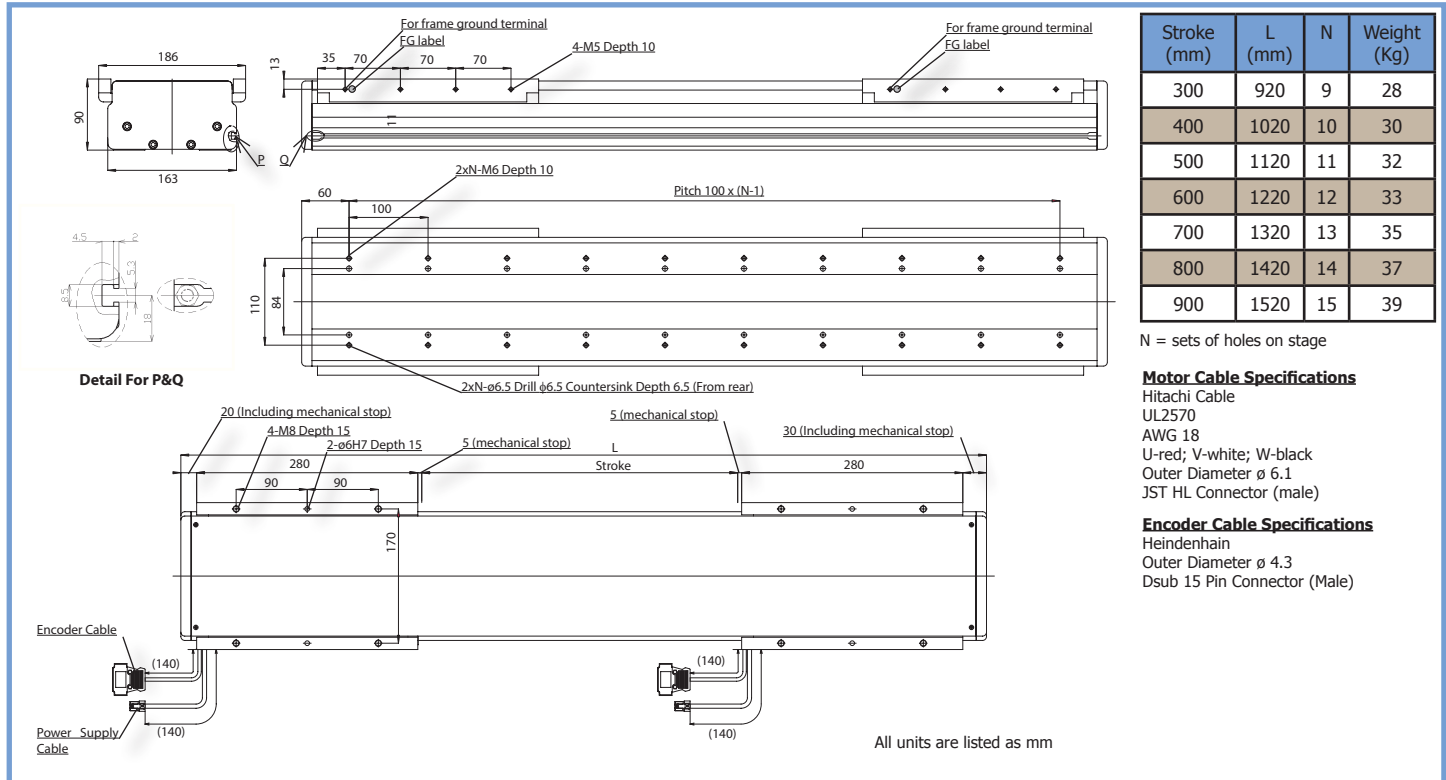

Sold & Serviced By:



Toll Free Phone: 877-378-0240

Toll Free Fax: 877-378-0249

sales@servo2go.com

www.servo2go.com