

LINTECH[®]

Round Rail Components

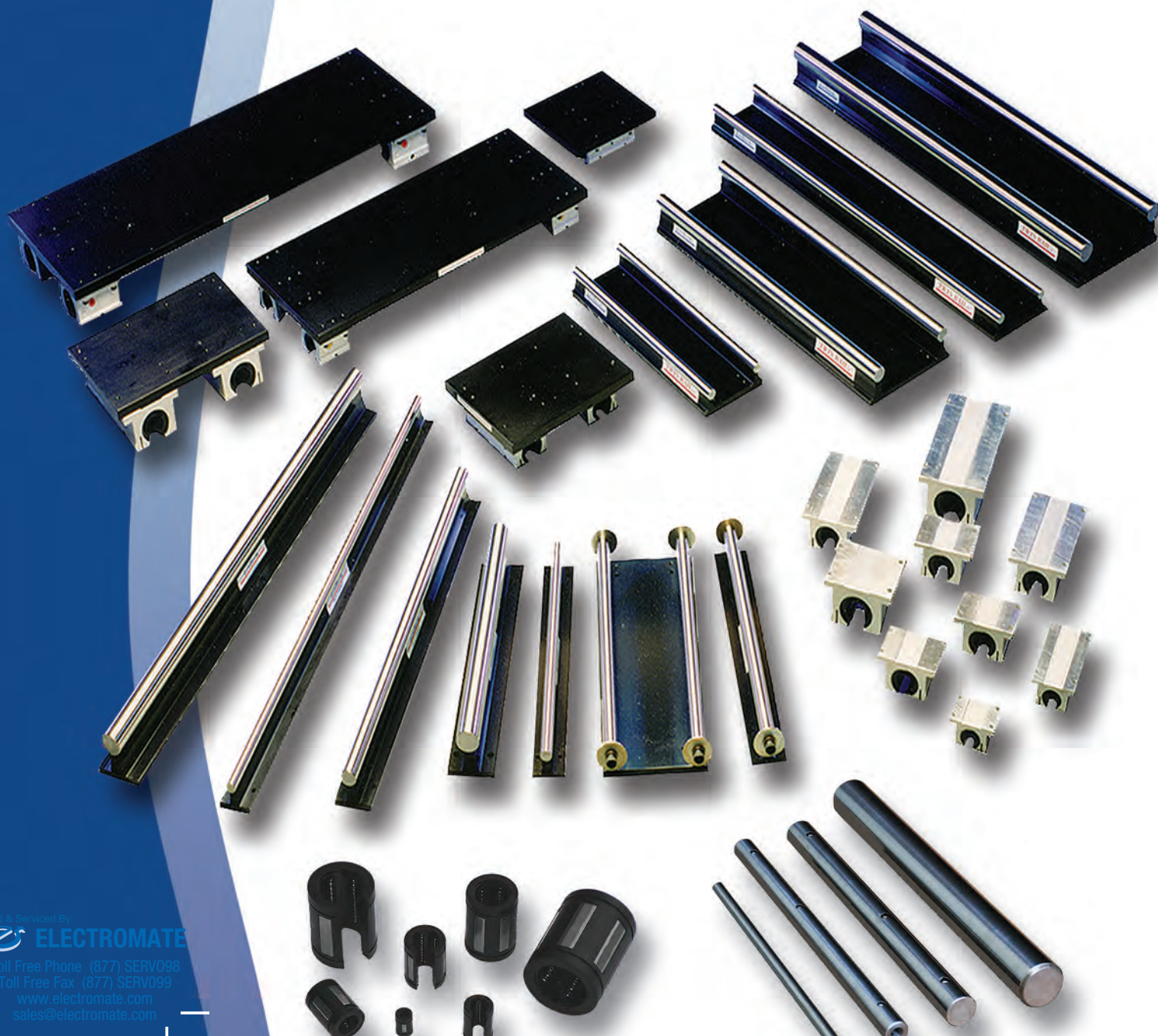

Sold & Serviced By
ELECTROMATE

Toll Free Phone (877) SERV098
Toll Free Fax (877) SERV099
www.electromate.com
sales@electromate.com

Table of Contents

	Pages
Design Considerations	2 to 16
Linear Bearings, Pillow Blocks and Carriage Assemblies	17 to 36
Precision Shafting, Shaft Supports and Shaft Assemblies	37 to 65
Terms of Sale	Inside Back Cover

Sold & Serviced By:

 **ELECTROMATE**

Toll Free Phone (877) SERV098

Toll Free Fax (877) SERV099

www.electromate.com

sales@electromate.com

Precision Shafting

LINTECH's precision "cut to length" 1060 carbon steel inch precision shafting is manufactured with the highest standards for surface finish, surface hardening, roundness and straightness. These manufacturing procedures provide a quality shaft with long life and optimum performance in today's demanding applications. Inch diameters are available from 0.25 to 2.0 inches in class L, S and N diameter tolerances. Metric diameters are available from 8 to 50 mm. Any length is available within .001 inch increments, up to the standard maximum stocked length.



ES End Shaft Support Blocks

LINTECH's aluminum and steel end support housings (ES series) provide a simple means to fix the ends of a shaft to a mounting surface. The ES-S series is manufactured from 1045 steel, while the ES-A series is manufactured from 6061-T6 aluminum.



ARS & LSRS Shaft Supports

LINTECH's aluminum and steel shaft supports provide a simple means to fix a shaft to a user mounting surface in an application that requires the shaft to be fully supported over its entire length. The ARS series is manufactured from 6061-T6 aluminum, while the low profile LSRS series is manufactured from C-1018 steel.



SA Shaft Assemblies

LINTECH's single Shaft Assembly (SA series) is a complete assembly which simplifies the use of a linear bearing in a mechanical positioning application. Each assembly has a steel shaft mounted to a black anodized, precision machined, aluminum support. The pre-drilled base mounting holes in the 6, 12, 18, and 24 inch supports allow for easy customer mounting. The SA assemblies come in standard lengths from 6 to 192 inches, and with shaft diameters from 0.50 to 2.00 inches.

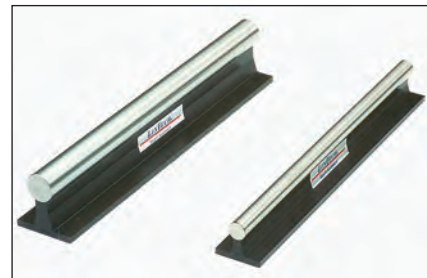

TRSA Shaft Assemblies

LINTECH's TWIN RAIL® Shaft Assembly (TRSA series) is a complete assembly which simplifies the use of a linear bearing in a mechanical positioning application. Two steel shafts are mounted and aligned on the common base, therefore eliminating the alignment process required for two separate shafts. The pre-drilled base mounting holes in the support allow for easy customer mounting. Each 6, 12, 18, and 24 inch aluminum support has two threaded holes at one end to assist in leveling the assembly. The TRSA comes in standard lengths from 6 to 192 inches, and with shaft diameters from 0.50 to 2.00 inches.



LBCA & LBOA Precision Linear Bearings

LINTECH's LBCA & LBOA offer an "all steel" linear bearing design. This provides for operation in high temperature environments (up to + 600° F) and can offer a smoother operation when compared to the LBC & LBO style bearings for some applications.



LBC, LBO & Metric High Capacity Linear Bearings

LINTECH's high capacity linear bearings have a ball conforming outer race coupled with a self-aligning feature which allows for zero bearing clearance while maintaining smooth operation. The independently self-aligning outer bearing races insure smooth operation by allowing miss-alignment up to 1/2 degree in all directions. These linear bearings are available in "open" or "closed" styles. The closed style is available in 0.25 to 2.00 inch nominal diameters, while the open style is available in 0.50 to 2.00 inch nominal diameters. Metric style diameters are available from 16 mm to 50 mm.



SLBO, SLBC, DLBC & DLBO Pillow Blocks

LINTECH's SLBC and SLBO series have one linear bearing and two wiper seals per pillow block, and are self-aligning in all directions. The SLBO and DLBO series have a screw for pre-load adjustment to reduce the shaft and bearing clearance. LINTECH's DLBC and DLBO series have two linear bearings in one aluminum pillow block, separated by a wick that serves as an oil reservoir. Each pillow block housing provides a flat top surface for load mounting and alignment.

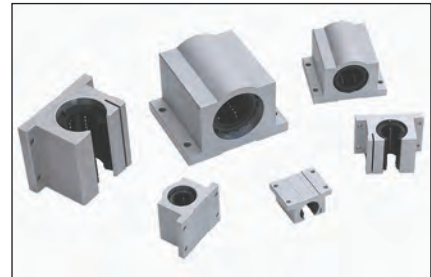

TRCA Carriage Assemblies

LINTECH's TRCA series, TWIN RAIL® carriage assemblies are pre-engineered assemblies which have either SLBO or DLBO pillow blocks mounted to a 6061-T6 aluminum, black anodized machined plate. The pillow blocks are pre-aligned and doweled to the carriage plate to match LINTECH's TRSA series shaft assemblies. The use of a TRCA carriage assembly and a TRSA shaft assembly reduces the process of mounting and aligning two shafts and pillow blocks. Each carriage surface is machined which allows for accurate mounting of customer loads, and are available with mounting holes with stainless steel inserts. Carriage assemblies are provided with pillow blocks for shaft diameters from 0.50 to 2.00 inches, and come in lengths from 6 to 30 inches.

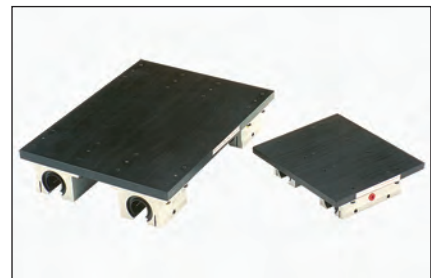

Options

LINTECH can provide many options which allow the user to customize a product for their application requirements. These include: metric shaft assemblies, tubular shafting, bearing locks, metric linear bearings, special finishes, custom TWIN RAIL® assembly widths and lengths, etc.. Contact the factory if a desired option is not shown in this catalog.

Precision Steel Shafts

LINTECH's precision shafting, SA and TRSA shaft assemblies use Rockwell 60-65C hardened and ground shafts. These high quality carbon steel shafts are accurately machined and heat treated for uniform hardness. They are also inspected for straightness, roundness, and smoothness. The high hardness and extremely smooth surface of the steel shafts creates an abrasion-resistant surface, which reduces material wear and system friction, while maintaining an optimal surface finish. Inch and Metric shaft diameters are available in different shaft tolerances.

Stainless Steel Shafts

For corrosion resistant applications, **LINTECH** provides 440C stainless steel shafts with the same shaft diameter tolerance, hardness depth, and straightness as our standard steel shafts. Stainless steel shafts are typically used in the chemical and food processing industries, for medical equipment in corrosive environments, or in strong oxidizing atmospheres where no lubricating oil is available.

Chrome Plated Shafts

LINTECH can also provide chrome plated precision shafting for those demanding applications that required a high level of corrosion resistance.

Shaft Diameter Tolerance

LINTECH shafts are precision ground to a very close diameter tolerance. This diameter tolerance is an extremely important factor when using **LINTECH** linear bearings. It assures a dependable fit, with proper clearance between a shaft and linear bearing.

Shaft Hardness

The hardness of a steel shaft is its ability to prevent nicks, indentations, or grooving. It is an important factor in determining the life of a linear bearing system in an application. The heat treatment process performed on all shafts assures uniform hardness in radial and axial directions.

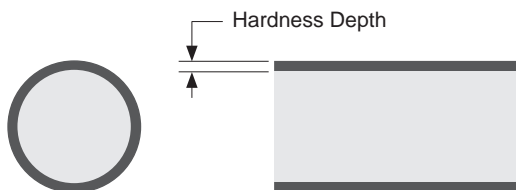

Shaft Straightness

The exceptional straightness of all shafts eliminate system binding when using a TRSA shaft assembly with a TRCA carriage assembly, and helps the alignment process when using two precision shafts, or SA shaft assemblies, in a parallel assembly application.

Shaft Supports

LINTECH ES end supports use 6061-T6 aluminum (-A), or 1045 steel (-S). These supports slide over the hardened shaft, and have a screw that is adjusted to clamp the support onto the shaft. The ARS series assembly support is manufactured from aluminum, while the low profile LSRS series is manufactured from C-1018 steel and functions the same as the ARS series, but has a smaller overall height.

ES-A Series

ES-S Series

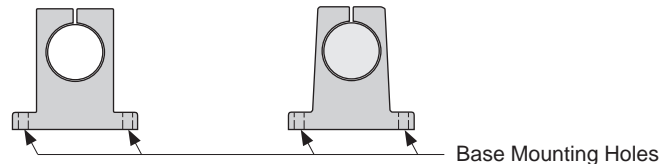

ARS Series

LSRS Series

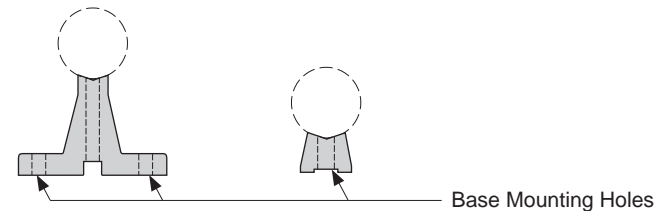

Shaft Assemblies

LINTECH shaft assemblies (SA and TRSA series) use 6061-T6 precision machined aluminum supports. These black anodized supports have pre-drilled base mounting holes that come in both single supports for the SA, and **TWIN RAIL**® supports for the TRSA. These precision machined supports come in 6, 12, 18, and 24 inch lengths, and can be combined for nearly unlimited assembly lengths.

SA Series - single rail supported assembly

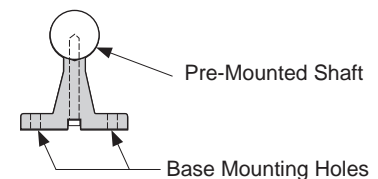

TRSA Series - **TWIN RAIL**® supported assembly

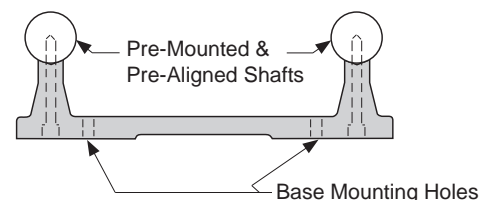

Precision Steel Linear Bearings

LINTECH's LBCA and LBCO precision steel linear bearings are manufactured with high quality steel that is hardened and precision ground. The recirculating precision ground bearing balls roll freely into and out of the load zone. The balls are guided through their recirculation path by a steel retainer and hardened sleeve. These bearings are used in high temperature applications and where self alignment is not required.

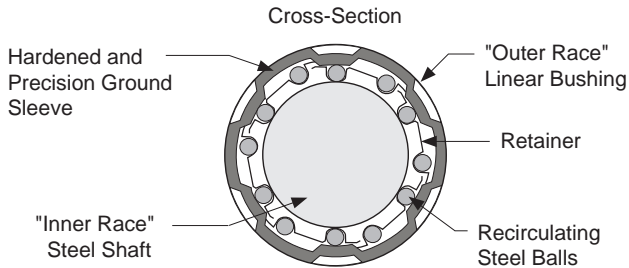

Pillow Blocks

LINTECH's SLBC, SLBO, DLBC and DLBO series pillow blocks use one or two, LBC or LBO, linear bearings with integral seals to obtain their long life, and high load capacity. The precision machined 6061-T6 aluminum pillow block mounting surface allows for accurate and easy mounting to a common carriage plate. The SLBO and DLBO pillow block models have an adjusting screw to permit adjustment of radial play between the "inner race" steel shaft and the "outer race" linear bearing. A retention pin is used to secure the linear bushing within the aluminum housing.

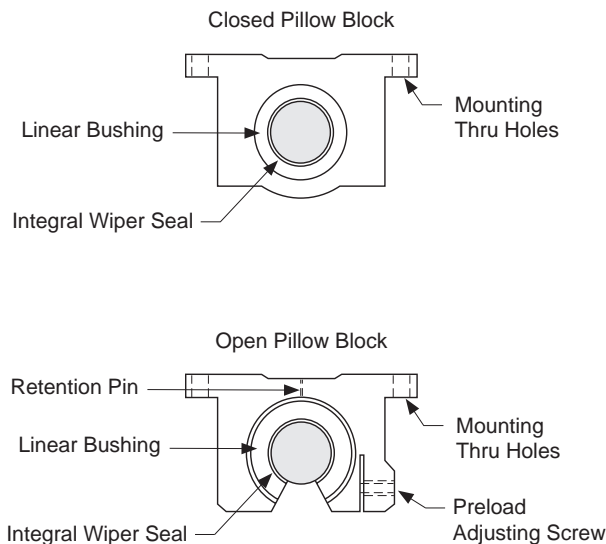

Self-Aligning Linear Bearings

LINTECH's LBC, LBC and Metric style linear bearings consists of a wear resistant, low friction, smooth, resilient, plastic ball retainer and plastic outer sleeve. The load carrying components of the linear bearing are precision machined, hardened steel bearing plates, and recirculating steel balls. There are longitudinal grooves along the inner surface of the steel bearing plates which contact the recirculating steel balls. The steel bearing plate is also designed slightly thicker in the middle than at either end. This tapered thickness along the bearing plate length allows the bearing plate to automatically align itself with the "inner race" steel shaft. This assures smooth entry and exit of the recirculating steel balls in and out of the load area, along with a more uniform load distribution within the linear bearing.

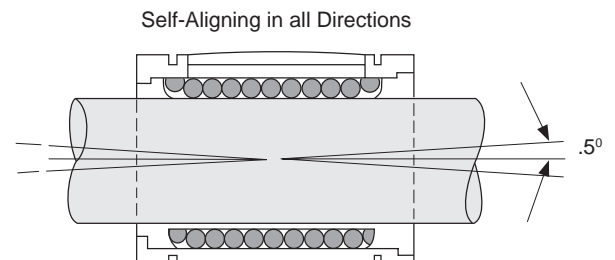
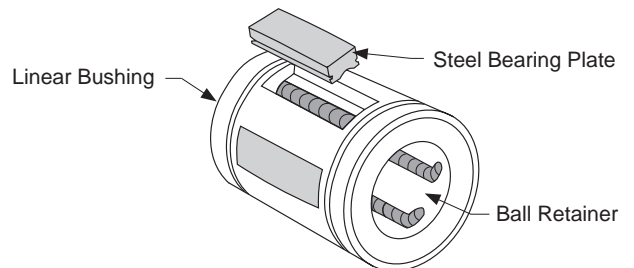
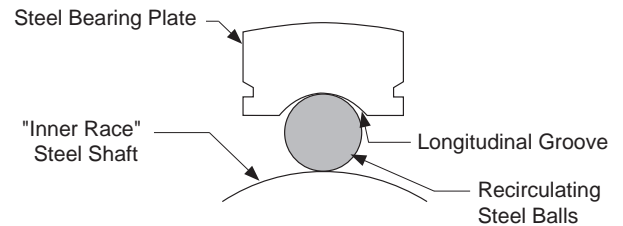
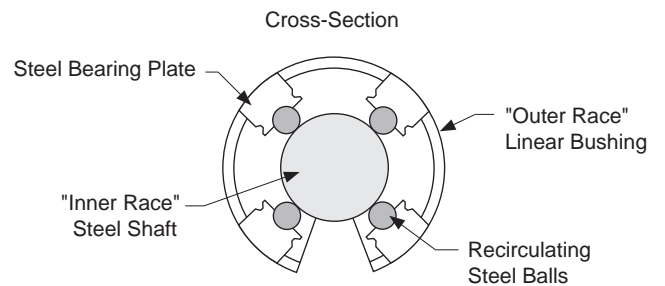

Travel Life

The rated life of a linear bearing, pillow block or carriage assembly is measured in inches (or km) of travel under a specified load. The failure of a linear bearing system occurs when the operating stresses from the rolling balls in the linear bushing cause material fatigue, resulting in flaking of the steel balls or steel shaft and/or grooving in the steel shaft.

Every linear bearing, pillow block or carriage assembly has a dynamic load rating associated with it based on a L_{10} life of 2 million inches of travel (approximately 50 km). For most applications, knowing the load applied to a linear bearing and the life required is all that is needed in selecting the proper components for the task at hand.

For more demanding applications the hardness of the shaft used, operating temperature, direction of the load, additional shock loads, and linear speed of the bearing are all factors that should be considered. This allows for an accurate prediction of the dynamic life of a linear bearing, pillow block or carriage assembly in a specific application.

Load Ratings

The applied load that a linear bearing, pillow block or carriage assembly will see needs to be compared against the load capacity of that component. The dynamic load rating of a linear bearing, pillow block or carriage assembly pertains to the component in motion and this load rating is based on the number of inches (or km) traveled.

Required Life

It is important to evaluate the required or expected life from a linear bearing system for a given application load. This required life is specified by the user as the desired life prior to a possible failure. This period of time (usually in years) then will need to be converted into a travel distance (typically inches or km) to select the appropriate size linear bearing, pillow block or carriage assembly.

Required Life Examples

Below are two examples which illustrate the importance of a dynamic load rating based upon travel life. These two applications could lead to the selection of different components due to the difference in the number of required inches of travel, even though the the applied load is the same 150 lbs (68 kg).

Example 1:

assembly needs to last 6 years
with
a 10 inch move out, then back 10 inches every 90 seconds
for
8 hours per day
for
5 days per week
and
50 weeks per year

$$\frac{(10 \times 2) \text{ inches}}{90 \text{ sec}} \times \frac{60 \text{ sec}}{1 \text{ min}} \times \frac{60 \text{ min}}{1 \text{ hr}} \times \frac{8 \text{ hr}}{1 \text{ day}} \times \frac{5 \text{ days}}{1 \text{ week}} \times \frac{50 \text{ weeks}}{1 \text{ yr}} \times 6 \text{ years} = \mathbf{9,590,400} \text{ inches of travel}$$

Example 2:

assembly needs to last 8 years
with
(24) 1 inch moves out, then back 24 inches every 30 seconds
for
12 hours per day
for
7 days per week
and
52 weeks per year

$$\frac{(24 \times 2) \text{ inches}}{30 \text{ sec}} \times \frac{60 \text{ sec}}{1 \text{ min}} \times \frac{60 \text{ min}}{1 \text{ hr}} \times \frac{12 \text{ hr}}{1 \text{ day}} \times \frac{7 \text{ days}}{1 \text{ week}} \times \frac{52 \text{ weeks}}{1 \text{ yr}} \times 8 \text{ years} = \mathbf{201,277,440} \text{ inches of travel}$$

Safety Factors

As a practice, safety factors should always be used when selecting a linear bearing, pillow block or carriage assembly for a given application. For most real world applications people do use safety factors. However, sometimes the incorrect safety factor or no safety has been used. This can lead into an unexpected system failure. **LINTECH** provides, in a chart form, different safety factor recommendations for linear bearings, pillow blocks or carriage assemblies. Keep in mind that these recommendations for safety factors are not hard and fast rules. Safety factors for a specific linear bearing system may have to be increased or decreased based upon the application requirements.

Linear Bearing Load Capacities

Linear Bearing Load Capacities are usually specified with a dynamic value. These values are used to help select the proper linear bearing, pillow block or carriage assembly size for a given load/life application. The use of adequate safety factors is a key element in the selection process of a linear bearing system for a given application. Selecting a bearing system with no safety margin can lead to problems relating to performance and long term life.

Dynamic Load Capacity

Dynamic Loads exert a force upon the linear bearing, pillow block or carriage assembly while in motion. Every linear bearing system has a load capacity associated with it that is based upon the number of inches (or km) traveled. If the load applied to the linear bearing system is less than the rated value at 2 million inches (or 50 km) of travel, the linear bearings will have a longer life associated with them that is exponential. Therefore, to properly select a linear bearing, pillow block or carriage assembly that will last the required travel life for an application, the forces acting upon the linear bearings need to be reviewed. Once the force on the heaviest loaded bearing has been determined and a proper safety factor selected, then the life of that bearing, pillow block or carriage assembly can be determined by using a simple mathematical equation.

Even though the forces acting upon a bearing, pillow block or carriage assembly can be calculated, other parameters such as changing loads, speeds, acceleration rates, environments, and lack of lubrication produce extra forces (stresses) that are hard to quantify. As a bearing moves, there are additional resultant loads as a by-product. The rate at which the bearing begins to move a load can have a large impact on its life. The linear bearings see this start/stop rate as a shock load each time. These and other variable loads cannot be calculated precisely. Thus, a safety factor should be applied to account for these loads which could fatigue the system and cause premature failure. See the below chart as a guideline.

Recommended Linear Bearing Dynamic Safety Factors

Impacts or Vibration	Speed (in/sec)	Acceleration (G's)	Min. Safety Factor - S
None	< 5	< 0.25	1.0 - 2.0
Small	5 - 10	0.25 - 0.50	2.0 - 3.0
Medium	10 - 20	0.50 - 1.00	3.0 - 4.0
Large	20 - 50	1.00 - 1.50	4.0 - 6.0
Very Large	> 50	> 1.50	6.0 - 8.0

Safety Factor Example

The application calls for moving a part (weight = 150 lbs) that is mounted to a carriage assembly. The carriage assembly will be moved to various positions at a speed of 9 IPS, with an acceleration of 0.75 G's.

From above chart - use a 3.5 safety factor

Load Safety Factor *Select a carriage assembly that has a dynamic capacity greater than this value*

$$150 \times 3.5 = 525 \text{ lbs}$$

Hardness factor - F_H

The maximum travel life of a linear bearing is achieved when the shaft surface has a hardness value greater than (>) Rockwell 60C. This hardness assures that no shaft grooving or flaking will occur under normal operating conditions.

<i>LINTECH</i> SL, SS, SN, SM, SA & TRSA	Rockwell Hardness	F_H factor
standard 1060 steel shafts	60-65C	1.00
440C stainless steel shafts	50-55C	.52
chrome plated 1060 steel shafts	67-72C	1.00

When using *LINTECH* bearings, pillow blocks or TRCA carriage assemblies with different shafting and hardness ratings, refer to the Shaft Hardness graph below for the correction factor.

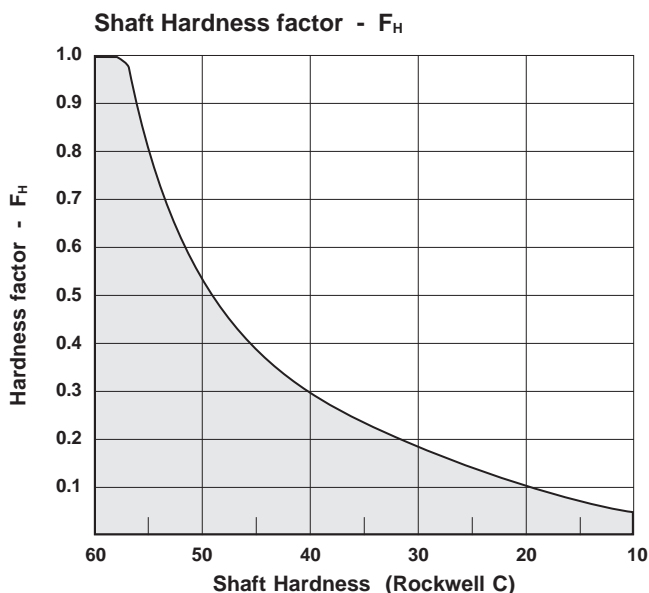

Temperature factor - F_T

Ambient temperatures over 212° F (100° C) will fatigue any linear bearing system, and will cause a decrease in travel life. Please note that some *LINTECH* linear bearings, pillow blocks and carriage assemblies have a maximum operating ambient temperature of 185° F. Therefore these bearings, pillow blocks or carriage assemblies, should never be used in ambient temperatures above 185° F.

Refer to the temperature graph below for the correction factor when using a linear bearing system in an ambient temperature that exceeds 212° F (100° C).

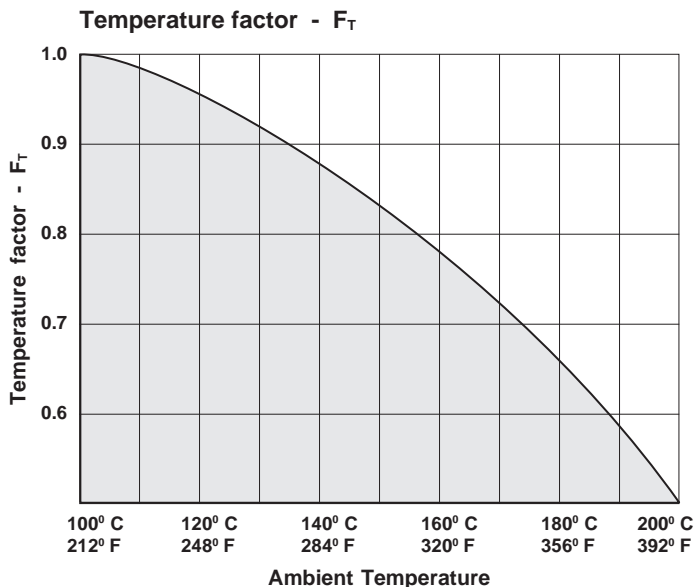

Load direction factor - F_L

The maximum travel life of a linear bearing, pillow block or carriage assembly may need to be de-rated depending upon the direction the load is applied to the bearing. The Polar charts shown below for each bearing type indicate the de-rating factor (or multiplier) based upon the direction the load is applied to the bearing. In most applications not all the bearings will see the same applied load, so you can use the adjacent equation to determine the estimated life based upon the heaviest loaded bearing or the bearing which requires the greatest de-rating factor. This will yield a system life value showing the bearing which has the lowest overall travel life. To use the below graphs, simply find the intersecting point based upon the direction of the load (that the bearing sees) and then use the de-rating factor (i.e. 0.9, etc.), if any.

$$L = \left[F_H \times F_T \times F_L \times \frac{R}{F \times S} \right]^3 \times B$$

- L = normal travel life millions of inches (or Km)
- R = rated dynamic load capacity of linear bearing, or carriage at 2 million inches of travel (or 50 Km)
- F = user applied load
- B = either 2 millions of inches (or 50 Km)
- F_H = shaft hardness factor
- F_T = environment temperature factor
- F_L = load direction factor
- S = dynamic safety factor

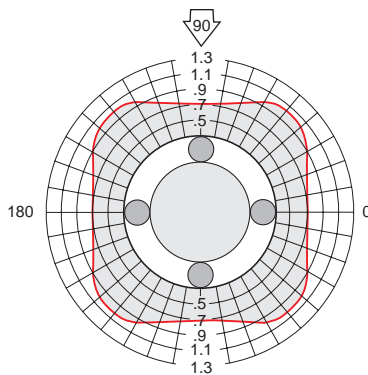

LBC-4
LBC-6, LBCA-6
LBC-8, LBCA-8, SLBC-8, DLBC-8
LBCA-10

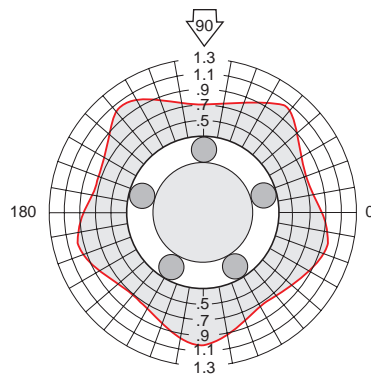

LBC-10, SLBC-10, DLBC-10
LBCA-12, LBCA-16
LBCM-16, LBCME-16

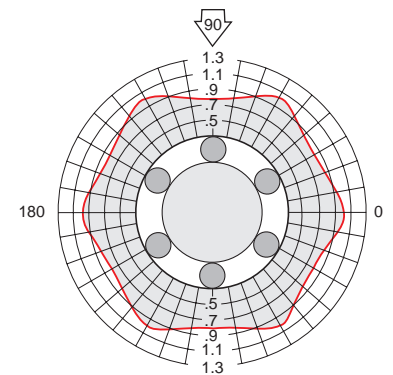

LBC-12, SLBC-12, DLBC-12
LBC-16, SLBC-16, DLBC-16
LBC-20, LBCA-20, SLBC-20, DLBC-20
LBC-24, LBCA-24, SLBC-24, DLBC-24
LBC-32, LBCA-32, SLBC-32
LBCM-20, LBCM-25, LBCM-30, LBCM-40
LBCME-20, LBCME-25, LBCM-30
LBCME-40, LBCME-50

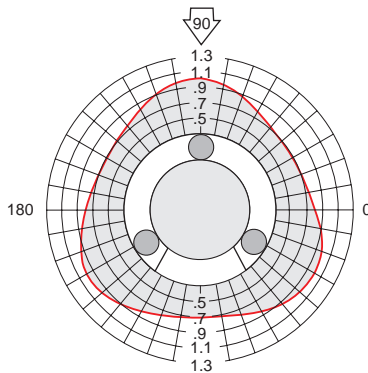

LBCA-4
LBO-8, LBOA-8,
SLBO-8, DLBO-8
LBOA-10

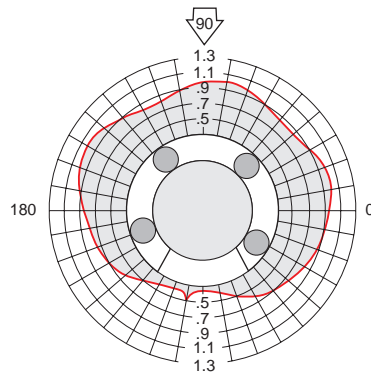

LBO-10, SLBO-10, DLBO-10
LBOA-12, LBOA-16
LBOM-16, LBOME-16

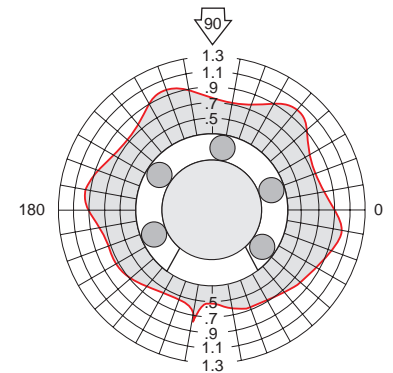

LBO-12, SLBO-12, DLBO-12
LBO-16, SLBO-16, DLBO-16
LBO-20, LBOA-20, SLBO-20, DLBO-20
LBO-24, LBOA-24, SLBO-24, DLBO-24
LBO-32, LBOA-32, SLBO-32
LBOM-20, LBOM-25, LBOM-30, LBOM-40
LBOME-20, LBOME-25, LBOM-30
LBOME-40, LBOME-50

Lubrication

LINTECH shafts, shaft assemblies, linear bearings, pillow blocks or carriage assemblies require a small amount of grease or oil for proper, long term operation. Lubrication will decrease system wear and the potential for rusting of shafts and linear bearing surfaces. For most applications a medium to heavy oil, light grease, or silicone based lubricant is recommended. The many built-in pockets within the linear bearing allows the adhesive properties of these lubricants to be stored for extended periods of time while minimizing sealing problems.

To obtain the estimated travel life for a given application, the linear bearings, pillow blocks or carriage assemblies should not run dry for an extended period of time. This lubrication schedule will ultimately need to be determined empirically during operation at the installation site since it can vary depending upon the environment, operation conditions, quantity and type of lube used, and other unforeseen conditions.

All **LINTECH** shafts, shaft assemblies, linear bearings, pillow blocks and carriage assemblies are shipped lightly coated with a rust preventative oil in the bearings or on the shafts. This will help prevent corrosion during the shipping period of the product. It is highly recommended that all shafts, shaft assemblies, linear bearings, pillow blocks and carriage assemblies be lubricated during installation or prior to operation. Also, periodic re-lubrication of the linear bearings and shafts, will help assure that the rated life of the system is obtained.

NOTE: Use of WD-40 or other cleaning solvents should strictly be avoided as they can cause damage to the linear bearing and shaft.

Frictional Resistance

The total friction resistance of a **LINTECH** linear bearing, pillow block or carriage assembly can be calculated by using the following equation.

$$R = [W \times \mu] + F_s$$

R = Frictional resistance (lbs)

W = Load weight (lbs)

μ = coefficient of friction

F_s = Frictional resistance - seal drag (lbs)

Note: **LINTECH** recommends using **μ** = .01 for all linear bearing systems.

The coefficient of friction (**μ**) of a **LINTECH** linear bearing, pillow block or carriage assembly consists of the rolling friction and the static (breakaway) friction. Two main factors affect the coefficient value. The type of lubrication used (i.e. oil, grease, or none) and the ratio between the total load weight and the dynamic load rating of the linear bearing, pillow block or carriage assembly used.

For most applications, **LINTECH** recommends using a value of .01 for the coefficient of friction. This value can be used for all linear bearings systems. The .01 value provides for an adequate safety margin when evaluating system performance. Other frictional resistances of a **LINTECH** linear bearing are seal drag and system preload. While wiper seals are used to retain lubricants and prevent entry of foreign particles into the linear bearing, they will increase the frictional resistance of the system. Increasing the preload of a linear bearing will also add extra frictional resistance. The chart below lists the nominal values for frictional seal drag of **LINTECH** linear bearings, pillow blocks and carriage assemblies.

Frictional Resistance - F_s (seal drag)

Bearing size -S (Sealed Versions) and Pillow Blocks	F _s (lbs)	Carriage Model TRCA series	F _s (lbs)
Single, 0.50" diameter	0.5	TRCA-8-xx	2.0
Single, 0.62" diameter	0.4	TRCA-10-xx	1.6
Single, 0.75" diameter	0.4	TRCA-12-xx	1.6
Single, 1.00" diameter	0.4	- TRCA-16-xx	1.6
Single, 1.25" diameter	5.0	TRCA-20-xx	20.0
Single, 1.50" diameter	7.0	TRCA-24-xx	28.0
Single, 2.00" diameter	8.0	TRCA-32-xx	32.0
Double, 0.50" diameter	0.5	TRCA-8-6	1.0
Double, 0.62" diameter	0.4	TRCA-10-6	0.8
Double, 0.75" diameter	0.4	TRCA-12-6	0.8
Double, 1.00" diameter	0.4	TRCA-16-6	0.8
Double, 1.25" diameter	5.0	TRCA-20-8	10.0
Double, 1.50" diameter	7.0	TRCA-24-12	14.0

All individual bearing force equations below pertain to a four bearing carriage which is at constant uniform velocity or with the carriage at rest. During acceleration and deceleration intervals of a positioning system, the force exerted upon an individual bearing changes as the acceleration or deceleration rate varies. In most cases, the extra force acting upon an individual bearing during the acceleration interval is offset by a reduced force during the deceleration interval. Therefore, using just the constant uniform velocity equations will adequately determine the life of an individual bearing for a particular application.

- d_1 - distance between center lines of shafts or rails (in)
- d_2 - distance between center lines of linear bearing blocks (in)
- d_3 - distance between carriage center and load center of gravity (in)
- d_4 - distance between carriage center and load center of gravity (in)
- d_r - distance between carriage surface and linear bearings (in)
- F_{BX} - force acting upon bearing in X-axis direction (lbs)
- F_{BY} - force acting upon bearing in Y-axis direction (lbs)
- F_{BZ} - force acting upon bearing in Z-axis direction (lbs)
- W - load weight (lbs)

Horizontal Applications

Example #1

Example #2

$$F_{1z} = \frac{W}{4} + \left[\frac{W}{2} \times \frac{d_4}{d_2} \right] + \left[\frac{W}{2} \times \frac{d_3}{d_1} \right]$$

$$F_{2z} = \frac{W}{4} - \left[\frac{W}{2} \times \frac{d_4}{d_2} \right] + \left[\frac{W}{2} \times \frac{d_3}{d_1} \right]$$

$$F_{3z} = \frac{W}{4} + \left[\frac{W}{2} \times \frac{d_4}{d_2} \right] - \left[\frac{W}{2} \times \frac{d_3}{d_1} \right]$$

$$F_{4z} = \frac{W}{4} - \left[\frac{W}{2} \times \frac{d_4}{d_2} \right] - \left[\frac{W}{2} \times \frac{d_3}{d_1} \right]$$

Side Mounted Applications

$$F_{1z} = F_{3z} = \frac{W}{4} + \left[\frac{W}{2} \times \frac{d_4}{d_2} \right]$$

$$F_{2z} = F_{4z} = \frac{W}{4} - \left[\frac{W}{2} \times \frac{d_4}{d_2} \right]$$

$$F_{1y} \sim F_{3y} = \left[\frac{W}{2} \times \frac{d_3 + d_r}{d_1} \right]$$

Vertical Applications

$$F_{1x} \sim F_{3x} = \frac{W}{2} \times \frac{d_4 + d_r}{d_2}$$

$$F_{1y} \sim F_{3y} = \frac{W}{2} \times \frac{d_3}{d_2}$$

$$F_{1x} + F_{3x} \sim F_{2x} + F_{4x}$$

$$F_{1y} + F_{3y} \sim F_{2y} + F_{4y}$$

Mean Bearing Load Calculation

When the force acting upon an individual bearing varies, as is the case with the bottom axis bearings of a multi-axes positioning system, a mean bearing load calculation determines the life of that bearing.

$$F_{avg} = \frac{1}{3} (F_{min} + 2 \times F_{max})$$

- F_{avg} - average force acting upon bearing (lbs)
- F_{min} - minimum force acting upon bearing (lbs)
- F_{max} - maximum force acting upon bearing (lbs)

TRCA Rated Load Capacity

The **LINTECH** TRCA series, **TWIN RAIL**® carriage assembly consists of (2) DLBO or (4) SLBO series pillow blocks mounted to a precision machined aluminum plate. The pillow blocks are mounted, aligned, and then doweled in-place. They are designed to mate directly with the **LINTECH** TRSA series, **TWIN RAIL**® shaft assemblies. Using these two series in combination with each other will eliminate the requirement to align and set-up a mechanical positioning system to be parallel.

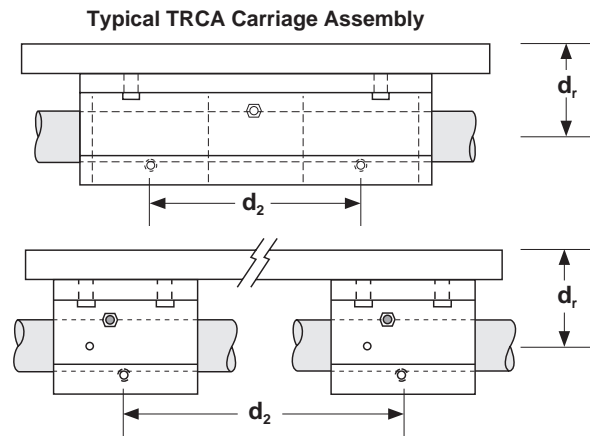

TRCA Carriage Assemblies

Model Number	Nominal Shaft Dia. (inches)	Carriage Length (inches)	Linear Bearing Used	Each Bearing ⁽¹⁾ Dyn. Load Capacity (lbs)	Dyn. Load Capacity ⁽¹⁾ (lbs)	d _r (inches)	d ₁ (inches)	d ₂ (inches)
TRCA8-6	0.500	6.00	DLBO-8	230	920	1.062	3.00	1.90
TRCA8-12	0.500	12.00	SLBO-8	230	920	1.062	3.00	10.00
TRCA8-18	0.500	18.00	SLBO-8	230	920	1.062	3.00	16.00
TRCA10-6	0.625	6.00	DLBO-10	320	1,280	1.250	3.75	2.15
TRCA10-12	0.625	12.00	SLBO-10	320	1,280	1.250	3.75	9.75
TRCA10-18	0.625	18.00	SLBO-10	320	1,280	1.250	3.75	15.75
TRCA12-6	0.750	6.00	DLBO-12	470	1,880	1.437	4.50	2.50
TRCA12-12	0.750	12.00	SLBO-12	470	1,880	1.437	4.50	9.62
TRCA12-18	0.750	18.00	SLBO-12	470	1,880	1.437	4.50	15.62
TRCA16-6	1.000	6.00	DLBO-16	780	3,120	1.687	5.25	3.25
TRCA16-12	1.000	12.00	SLBO-16	780	3,120	1.687	5.25	8.87
TRCA16-18	1.000	18.00	SLBO-16	780	3,120	1.687	5.25	14.87
TRCA16-24	1.000	24.00	SLBO-16	780	3,120	1.687	5.25	20.87
TRCA20-8	1.250	8.00	DLBO-20	1,170	4,680	2.250	6.00	3.90
TRCA20-12	1.250	12.00	SLBO-20	1,170	4,680	2.250	6.00	8.12
TRCA20-18	1.250	18.00	SLBO-20	1,170	4,680	2.250	6.00	14.12
TRCA20-24	1.250	24.00	SLBO-20	1,170	4,680	2.250	6.00	20.12
TRCA24-12	1.500	12.00	DLBO-24	1,560	6,240	2.750	6.62	5.00
TRCA24-18	1.500	18.00	SLBO-24	1,560	6,240	2.750	6.62	13.75
TRCA24-24	1.500	24.00	SLBO-24	1,560	6,240	2.750	6.62	19.75
TRCA24-30	1.500	30.00	SLBO-24	1,560	6,240	2.750	6.62	25.75
TRCA32-18	2.000	18.00	SLBO-32	2,350	9,400	3.375	7.25	12.75
TRCA32-24	2.000	24.00	SLBO-32	2,350	9,400	3.375	7.25	18.75
TRCA32-30	2.000	30.00	SLBO-32	2,350	9,400	3.375	7.25	24.75

Footnotes:

(1) Rating based upon 2 million inches of travel with the load forces being applied downward on the linear bearing, while in a horizontal application, and based upon 1060 steel shafting (Rockwell 60C). The actual load rating, and life, is dependent upon factors detailed on pages 6 to 11.

TRCA Rated Load Capacity

The dynamic load capacity of a *LINTECH* TRCA carriage assembly is based upon having the load forces centered on the carriage and the combined dynamic load capacity values of the SLBO or DLBO linear bearings used. The rated values are based on a L_{10} life of 2 million inches of travel (or 50 km) and with the load forces applied downward onto the carriage assembly.

For a given carriage assembly, as the load force decreases, the life of the carriage assembly will increase exponentially. The life of a carriage assembly, used in an application, can be determined by reviewing the load considerations found on pages 6 to 11.

TRCA Rated Moment Loads

When using a *LINTECH* TRCA carriage assembly in an application, a moment load exists when the load center of gravity is located away from the center of the carriage assembly. The life of a carriage assembly is determined by the heaviest loaded linear bearing. Follow the steps below to determine if a specific TRCA carriage assembly will operate sufficiently in a given application.

Step 1: Calculate the forces acting on each of the individual bearings for a given configuration and TRCA carriage assembly by using the equations on page 11.

Step 2: Compare the calculated values with the rated dynamic load capacity values for the SLBO or DLBO linear bearings used on the TRCA carriage assembly. Make sure the calculated values are below the rated values. **Note:** If the calculated forces are acting on the open end of a linear bearing, reduce the rated dynamic load capacity of that bearing by the value shown on the Polar Charts found on page 9.

Step 3: Follow the information on pages 6 through 11 to determine the theoretical travel life of the selected carriage assembly in inches (or km) of travel.

Load Centered on Carriage

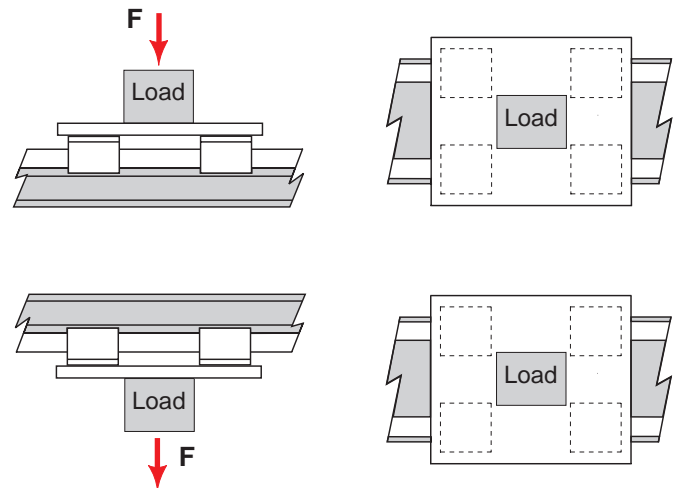

Load Center away from Carriage Center

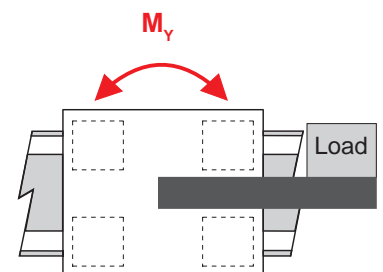
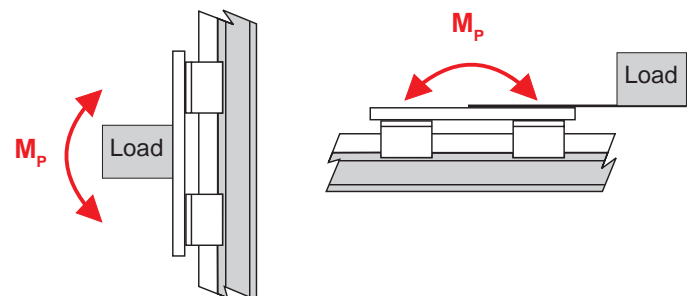
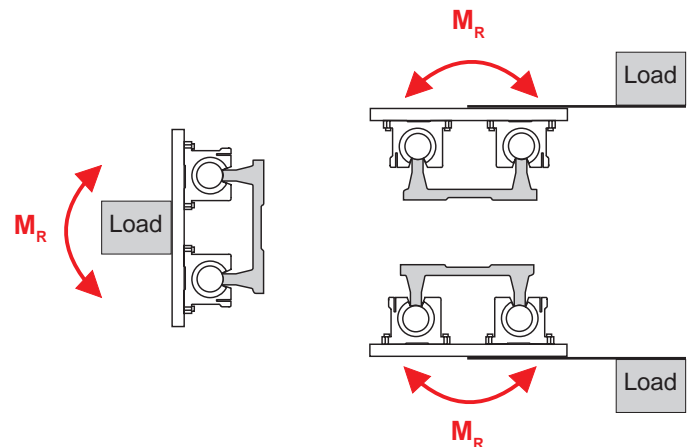

Shaft Deflection

The equations below can be used when *LINTECH* closed linear bearings (LBC, LBCA, SLBC or DLBC series), and precision hardened shafting is used with shaft end supports (ES series), or with threaded shaft ends attached to a plate on each end. The estimated deflection that a configuration will experience is dependent upon the shaft diameter, unsupported shaft length, shaft material, along with the type and number of bearings being used.

Minimizing the deflection of the components will reduce additional stresses which can lead to premature failure. Excessive deflection can cause binding or rough operation when the bearings are at the area of travel furthest from the supported portion, which is usually at mid-stroke.

- D** = deflection (inches) (mm)
- W** = user applied load (lbs) (N)
- L** = length of unsupported shaft (inches) (mm)
- C** = distance from support to center of first bearing (inches) (mm)
- T** = shaft weight per length (lbs/in) (N/mm)
- S_k** = strength constant - modulus of elasticity x moment of inertia

Model Number	Nominal Shaft Diameter (inches)	Shaft Weight T (lbs/in)	Strength Factor S _k (lb/in ²)
Sx4	0.250	0.014	5,700
Sx6	0.375	0.031	29,100
Sx8	0.500	0.055	91,800
Sx10	0.625	0.086	224,400
Sx12	0.750	0.125	465,000
Sx16	1.000	0.222	1,470,000
Sx20	1.250	0.348	3,594,000
Sx24	1.500	0.500	7,455,000
Sx32	2.000	0.890	23,562,000

Model Number	Nominal Shaft Diameter (mm)	Shaft Weight T (N/mm)	Strength Factor S _k (N/mm ²)
SM8	8	0.0038	38.26
SM10	10	0.0061	93.41
SM12	12	0.0087	193.70
SM16	16	0.0154	612.20
SM20	20	0.0240	1,495.00
SM25	25	0.0379	3,649.00
SM30	30	0.0542	7,566.00
SM40	40	0.0968	23,910.00
SM50	50	0.1513	58,380.00

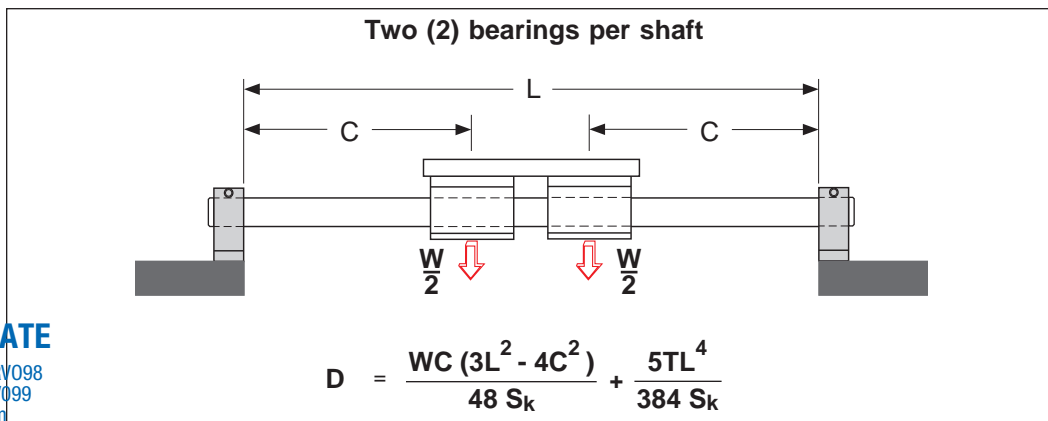
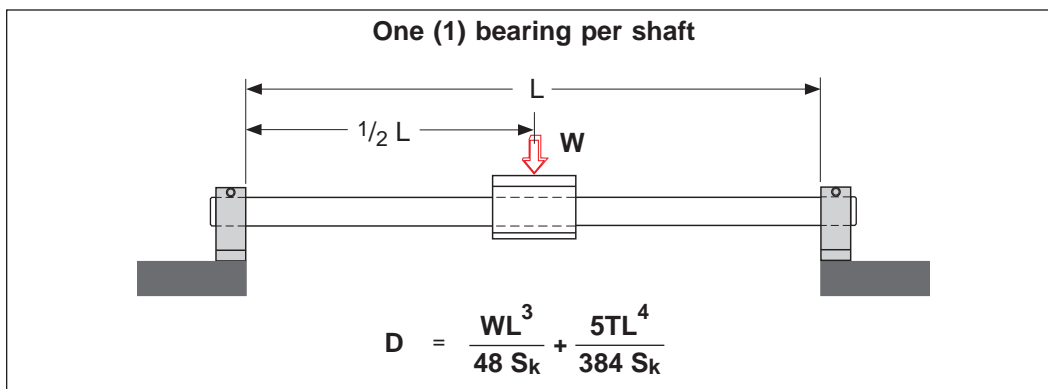

Life Example

The following example is provided to aid in the understanding of how the various charts and equations in this technical section should be implemented. For this example, the life estimation will be determined for an application that will use a **LINTECH** TRCA carriage assembly with a TRSA shaft assembly.

Application Parameters

The load weight of 100 lbs is centered on the TRCA carriage along with a 12 inch total travel in the horizontal plane. The **LINTECH** TRSA shaft assembly will use 440C stainless steel shafts, and will be mounted to a support structure so that the carriage will be inverted. Various outward moves will be made with a maximum return speed of 5 IPS. This return speed will be the most demanding speed profile in the application and the installation environment will be at 80^o F.

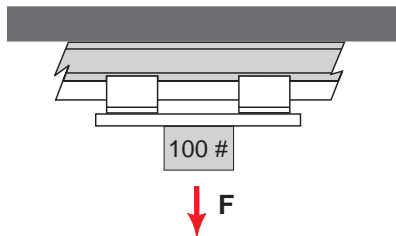

Different Options

In the application below, utilizing a custom carriage length which has six (6) SLBO-12 pillow blocks instead of two (2) DLBO-12 pillow blocks on the TRCA12 carriage assembly, would increase the R value from 1,880 to 2,820 lbs. Thus, increasing the L life estimate value to 98,538,824 inches of travel from 29,196,688 inches of travel.

Another option would be to utilize chrome plated shafts for the TRSA assembly instead of the 440C stainless steel shafts. This would increase the shaft hardness factor to 1 instead of 0.52. Thus, increasing the L life estimate value to 207,646,00 inches of travel from 29,196,688 inches of travel for just using the standard TRCA12-6.

Determine Safety and Correction Factors

- Step 1: Use chart on page 7 for 5 IPS to select a safety factor: $S = 2$
- Step 2: Use chart on page 8 for 440C to select a shaft hardness factor: $F_H = .52$
- Step 3: Use graph on page 8 for 80^o F to select a temperature factor: $F_T = 1$
- Step 4: Would like to use a TRCA12-6. From chart on page 12: $R = 1,880$ lbs
- Step 5: Use polar graph on page 9 to select load direction factor: $F_L = .5$
- Step 6: Use the equation on page 9 to compute the estimated life:

$$L = \left[F_H \times F_T \times F_L \times \frac{R}{F \times S} \right]^3 \times B$$

$$L = \left[.52 \times 1 \times .5 \times \frac{1880}{100 \times 2} \right]^3 \times 2,000,000$$

$$L = 29,196,688 \text{ inches of travel}$$

- Step 7: Use the equation on page 6 to determine the required life of your application. If the estimated L value above (for a 100 pound load) is less than your desired life, then select a larger carriage assembly from the chart on page 12, and then plug its dynamic load capacity for the R value into the equation above to re-calculate the estimated L life. As an example, the TRCA16-6 load rating of 3,120 lbs would increase the L life estimate to 133,451,615 inches of travel from 29,196,688 inches of travel.

Shafting & Shaft Assembly Applications

LINTECH shafts, shaft assemblies, linear bearings, pillow blocks and carriage assemblies are used in many different applications requiring mechanical motion. These components are utilized with air cylinders, hydraulic actuators, lead screws, rack & pinion systems, belt & pulleys, chain & sprockets, as well as in manual positioning systems. **LINTECH** individual shafts or SA shaft assemblies, along with individual linear bearings or pillow blocks, are typically used when a designer wishes to spread apart the shafts or SA shaft assemblies and make a custom carriage assembly. The TRSA shaft assemblies and TRCA carriage assemblies are utilized together when ease of installation is of essence.

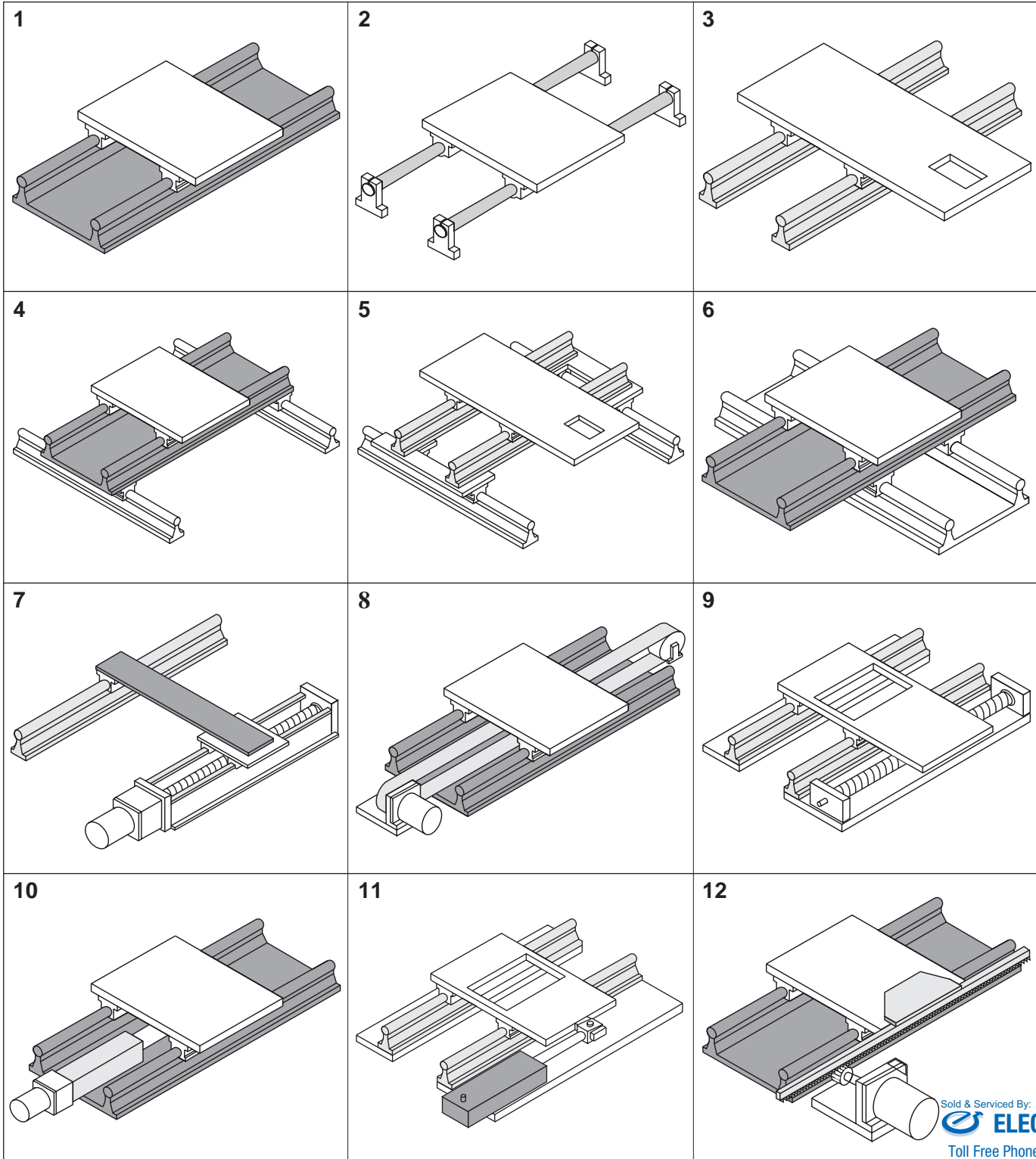

Linear Bearings, Pillow Blocks and Carriage Assemblies

LBCA & LBOA series _____	18 - 19
LBC & LBO series _____	20 - 21
LBCM & LBOM series _____	22 - 23
LBCME & LBOME series _____	24 - 25
Pillow Block series _____	26 - 28
TRCA series _____	29 - 32
Options _____	33 - 33
Metric Pillow Blocks _____	34 - 35

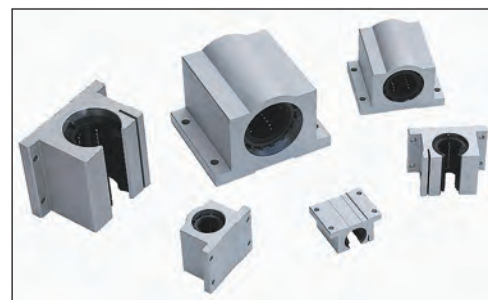

Sold & Serviced By:

 **ELECTROMATE**

Toll Free Phone (877) SERV098

Toll Free Fax (877) SERV099

www.electromate.com

sales@electromate.com



LBCA - **12** - **S**

Linear Bearing Series

- LBCA** - One Precision linear bearing (closed - all steel)
- LBOA** - One Precision linear bearing (open - all steel)

Nominal Diameter

- 4** - 0.250 inch diameter
- 6** - 0.375 inch diameter
- 8** - 0.500 inch diameter
- 10** - 0.625 inch diameter
- 12** - 0.750 inch diameter
- 16** - 1.000 inch diameter
- 20** - 1.250 inch diameter
- 24** - 1.500 inch diameter
- 32** - 2.000 inch diameter

Wiper Seals

- No seals
- S** - Seals at both ends

Specifications: LBCA & LBOA Linear Bearings

<p>Operating Temperature</p> <p>Maximum Speed</p> <p>Bearing Seals (optional)</p> <p>Matching Shaft</p>	<p>0° F to + 600° F (without seals) 0° F to + 185° F (with seals)</p> <p>10 ft/second</p> <p>Internal Wiper Seals on both ends, Plastic Bearing Retainer</p> <p>Class S (SS series), hardened & ground shafting (see pages 38 - 39)</p>					
<p>Housing Tolerances</p> <p>C = clearance</p>	<p>LBCA (closed style)</p>		<p>LBOA (open style)</p>			
	<p>Nominal Shaft Diameter (inches)</p>	<p>Recommended Housing Bore</p>		<p>Bearing and Shaft Fit-up (inches)</p>	<p>Nominal Shaft Diameter (inches)</p>	<p>Recommended Housing Bore before adjustment (inches)</p>
		<p>Normal Fit (inches)</p>	<p>Press Fit (inches)</p>			
	0.250	.5005 / .5000	.4995 / .4990	.0015C / .0005C		
	0.375	.6255 / .6250	.6245 / .6240	.0015C / .0005C		
	0.500	.8755 / .8750	.8745 / .8740	.0015C / .0005C	0.500	.8760 / .8740
	0.625	1.1255 / 1.1250	1.1245 / 1.1240	.0015C / .0005C	0.625	1.1260 / 1.1240
	0.750	1.2505 / 1.2500	1.2495 / 1.2490	.0015C / .0005C	0.750	1.2510 / 1.2490
	1.000	1.5630 / 1.5625	1.5620 / 1.5615	.0015C / .0005C	1.000	1.5635 / 1.5615
	1.250	2.0010 / 2.0000	1.9993 / 1.9983	.0015C / .0004C	1.250	2.0010 / 1.9990
	1.500	2.3760 / 2.3750	2.3743 / 2.3733	.0016C / .0005C	1.500	2.3760 / 2.3740
	2.000	3.0010 / 3.0000	2.9992 / 2.9982	.0020C / .0005C	2.000	3.0010 / 2.9990

Dimensions & Specifications: **LBCA** Precision Linear Bearing (closed)

Model Number		Nominal Shaft Diameter (inches)	Working Bore Diameter (inches)	Dyn. ⁽¹⁾ Load Capacity (lbs)	Dimensions (inches)				Bearing Weight (lbs)
Without Seals	With ⁽²⁾ Seals				A	B	C	D	
LBCA-4	LBCA-4-S	0.250	0.2500/0.2495	19	0.750/0.735	0.515/0.499	0.039	0.5000/0.4996	0.02
LBCA-6	LBCA-6-S	0.375	0.3750/0.3745	37	0.875/0.860	0.640/0.624	0.039	0.6250/0.6246	0.06
LBCA-8	LBCA-8-S	0.500	0.5000/0.4995	85	1.250/1.235	0.967/0.951	0.046	0.8750/0.8746	0.08
LBCA-10	LBCA-10-S	0.625	0.6250/0.6245	150	1.500/1.485	1.108/1.092	0.056	1.1250/1.1246	0.16
LBCA-12	LBCA-12-S	0.750	0.7500/0.7495	200	1.625/1.610	1.170/1.154	0.056	1.2500/1.2496	0.21
LBCA-16	LBCA-16-S	1.000	1.0000/0.9995	350	2.250/2.235	1.759/1.741	0.068	1.5625/1.5621	0.38
LBCA-20	LBCA-20-S	1.250	1.2500/1.2494	520	2.625/2.605	2.009/1.991	0.068	2.0000/1.9995	1.10
LBCA-24	LBCA-24-S	1.500	1.5000/1.4994	770	3.000/2.980	2.415/2.397	0.086	2.3750/2.3745	1.43
LBCA-32	LBCA-32-S	2.000	2.0000/1.9992	1,100	4.000/3.980	3.195/3.177	0.103	3.0000/2.9994	2.75

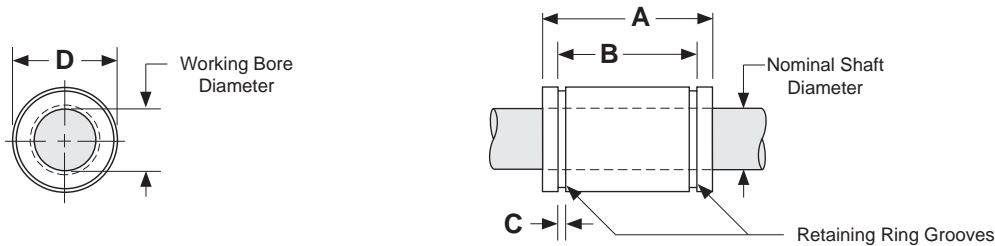

Dimensions & Specifications: **LBOA** Precision Linear Bearing (open)

Model Number		Nominal Shaft Dia. (inches)	Working Bore Diameter (inches)	Dyn. ⁽¹⁾ Load Cap. (lbs)	Dimensions (inches)					Bearing Weight (lbs)	Angle α
Without Seals	With ⁽²⁾ Seals				A	B	C	D	E _{min.}		
LBOA-8	LBOA-8-S	0.500	0.5005/0.4995	60	1.250/1.235	0.967/0.951	0.046	0.8760/0.8746	0.31	0.07	50°
LBOA-10	LBOA-10-S	0.625	0.6255/0.6245	105	1.500/1.485	1.108/1.092	0.056	1.1260/1.1240	0.38	0.11	60°
LBOA-12	LBOA-12-S	0.750	0.7505/0.7495	140	1.625/1.610	1.170/1.154	0.056	1.2510/1.2490	0.44	0.17	60°
LBOA-16	LBOA-16-S	1.000	1.0005/0.9995	240	2.250/2.235	1.759/1.741	0.068	1.5635/1.5615	0.56	0.32	60°
LBOA-20	LBOA-20-S	1.250	1.2506/1.2494	400	2.625/2.605	2.009/1.991	0.068	2.0010/1.9990	0.63	0.90	50°
LBOA-24	LBOA-24-S	1.500	1.5006/1.4994	600	3.000/2.980	2.415/2.397	0.086	2.3760/2.3740	0.75	1.12	50°
LBOA-32	LBOA-32-S	2.000	2.0008/1.9992	860	4.000/3.980	3.195/3.177	0.103	3.0010/2.9990	1.00	2.16	50°

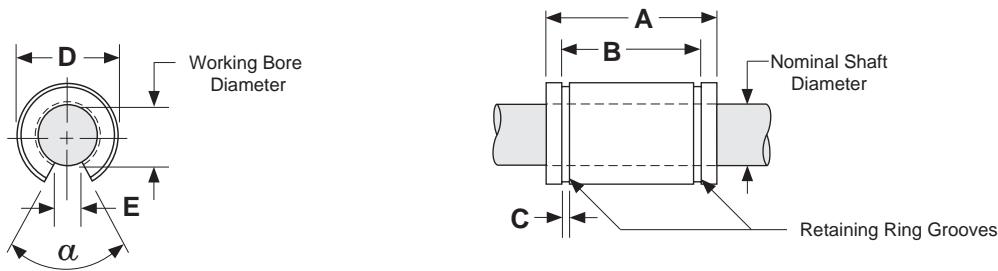

Footnotes:

- (1) Rating based upon 2 million inches of travel with the load forces being applied downward on the linear bearing, while in a horizontal application, and based upon 1060 steel shafting (Rockwell 60C). The actual load rating, and life, is dependent upon factors detailed on pages 6 to 11.
- (2) The bearing retainer is plastic when the internal -S seal option is selected.



LBC - **10** - **S**

Linear Bearing Series

- LBC** - One Linear Bearing Closed
- LBO** - One Linear Bearing Open

Nominal Diameter

- 4** - 0.250 inch diameter
- 6** - 0.375 inch diameter
- 8** - 0.500 inch diameter
- 10** - 0.625 inch diameter
- 12** - 0.750 inch diameter
- 16** - 1.000 inch diameter
- 20** - 1.250 inch diameter
- 24** - 1.500 inch diameter
- 32** - 2.000 inch diameter

Bearing Options

- No seals or corrosion resistance
- S** - Seals at both ends
- CR** - Corrosion Resistant without seals

Specifications: **LBC** & **LBO** Linear Bearings (self-aligning)

<p>Operating Temperature</p> <p>Maximum Speed</p> <p>Bearing Seals</p> <p>Matching Shaft</p>	<p>0° F to + 185° F</p> <p>9 ft/second</p> <p>Optional Internal Wiper Seals on both ends</p> <p>Class L (SL series), hardened & ground shafting (see pages 38 - 39)</p>																																																						
<p>Housing Tolerances</p> <p>C = clearance</p> <p>P = preload</p>	<table border="1"> <thead> <tr> <th rowspan="2">Nominal Shaft Diameter (inches)</th> <th colspan="2">Recommended Housing Bore</th> <th colspan="2">Bearing and Shaft Fit-up⁽¹⁾ (before adjustment)</th> </tr> <tr> <th>Fixed Housing (inches)</th> <th>Adjustable Housing (inches)</th> <th>Fixed Housing (inches)</th> <th>Adjustable Housing (inches)</th> </tr> </thead> <tbody> <tr> <td>0.250</td> <td>.5005 / .5000</td> <td>.5010 / .5000</td> <td>.0015C / .0000</td> <td>.002C / .0000</td> </tr> <tr> <td>0.375</td> <td>.6255 / .6250</td> <td>.6260 / .6250</td> <td>.0015C / .0000</td> <td>.002C / .0000</td> </tr> <tr> <td>0.500</td> <td>.8755 / .8750</td> <td>.8760 / .8750</td> <td>.0015C / .0000</td> <td>.002C / .0000</td> </tr> <tr> <td>0.625</td> <td>1.1255 / 1.1250</td> <td>1.1260 / 1.1250</td> <td>.0015C / .0000</td> <td>.002C / .0000</td> </tr> <tr> <td>0.750</td> <td>1.2505 / 1.2500</td> <td>1.2510 / 1.2500</td> <td>.0015C / .0000</td> <td>.002C / .0000</td> </tr> <tr> <td>1.000</td> <td>1.5630 / 1.5625</td> <td>1.5635 / 1.5625</td> <td>.0015C / .0000</td> <td>.002C / .0000</td> </tr> <tr> <td>1.250</td> <td>2.0008 / 2.0000</td> <td>2.0010 / 2.0000</td> <td>.0018C / .0001P</td> <td>.002C / .0000</td> </tr> <tr> <td>1.500</td> <td>2.3760 / 2.3750</td> <td>2.3760 / 2.3750</td> <td>.0021C / .0000</td> <td>.0021C / .0000</td> </tr> <tr> <td>2.000</td> <td>3.0010 / 3.0000</td> <td>3.0010 / 3.0000</td> <td>.0023C / .0002P</td> <td>.0023C / .0002P</td> </tr> </tbody> </table>	Nominal Shaft Diameter (inches)	Recommended Housing Bore		Bearing and Shaft Fit-up ⁽¹⁾ (before adjustment)		Fixed Housing (inches)	Adjustable Housing (inches)	Fixed Housing (inches)	Adjustable Housing (inches)	0.250	.5005 / .5000	.5010 / .5000	.0015C / .0000	.002C / .0000	0.375	.6255 / .6250	.6260 / .6250	.0015C / .0000	.002C / .0000	0.500	.8755 / .8750	.8760 / .8750	.0015C / .0000	.002C / .0000	0.625	1.1255 / 1.1250	1.1260 / 1.1250	.0015C / .0000	.002C / .0000	0.750	1.2505 / 1.2500	1.2510 / 1.2500	.0015C / .0000	.002C / .0000	1.000	1.5630 / 1.5625	1.5635 / 1.5625	.0015C / .0000	.002C / .0000	1.250	2.0008 / 2.0000	2.0010 / 2.0000	.0018C / .0001P	.002C / .0000	1.500	2.3760 / 2.3750	2.3760 / 2.3750	.0021C / .0000	.0021C / .0000	2.000	3.0010 / 3.0000	3.0010 / 3.0000	.0023C / .0002P	.0023C / .0002P
Nominal Shaft Diameter (inches)	Recommended Housing Bore		Bearing and Shaft Fit-up ⁽¹⁾ (before adjustment)																																																				
	Fixed Housing (inches)	Adjustable Housing (inches)	Fixed Housing (inches)	Adjustable Housing (inches)																																																			
0.250	.5005 / .5000	.5010 / .5000	.0015C / .0000	.002C / .0000																																																			
0.375	.6255 / .6250	.6260 / .6250	.0015C / .0000	.002C / .0000																																																			
0.500	.8755 / .8750	.8760 / .8750	.0015C / .0000	.002C / .0000																																																			
0.625	1.1255 / 1.1250	1.1260 / 1.1250	.0015C / .0000	.002C / .0000																																																			
0.750	1.2505 / 1.2500	1.2510 / 1.2500	.0015C / .0000	.002C / .0000																																																			
1.000	1.5630 / 1.5625	1.5635 / 1.5625	.0015C / .0000	.002C / .0000																																																			
1.250	2.0008 / 2.0000	2.0010 / 2.0000	.0018C / .0001P	.002C / .0000																																																			
1.500	2.3760 / 2.3750	2.3760 / 2.3750	.0021C / .0000	.0021C / .0000																																																			
2.000	3.0010 / 3.0000	3.0010 / 3.0000	.0023C / .0002P	.0023C / .0002P																																																			

Footnotes:

(1) Adjustable Housing Diameter (before adjustment) for LBO-20 is .002C/.0001P.

Dimensions & Specifications: **LBC** Linear Bearing (closed)

Model Number		Nominal Shaft Diameter (inches)	Dyn. ⁽¹⁾ Load Capacity (lbs)	Working Bore Diameter (inches)	Housing Bore ⁽²⁾ D (inches)	Dimensions (inches)			Bearing Weight (lbs)
Without Seals	With Seals					A	B	C	
LBC-4	LBC-4-S	0.250	60	0.2500/0.2495	0.5005/0.5000	0.750/0.735	0.511/0.501	0.039	0.01
LBC-6	LBC-6-S	0.375	105	0.3750/0.3745	0.6255/0.6250	0.875/0.860	0.699/0.689	0.039	0.02
LBC-8	LBC-8-S	0.500	265	0.5000/0.4995	0.8755/0.8750	1.250/1.230	1.032/1.012	0.050	0.04
LBC-10	LBC-10-S	0.625	420	0.6250/0.6245	1.1255/1.1250	1.500/1.480	1.105/1.095	0.056	0.10
LBC-12	LBC-12-S	0.750	640	0.7500/0.7495	1.2505/1.2500	1.625/1.605	1.270/1.250	0.056	0.14
LBC-16	LBC-16-S	1.000	1,045	1.0000/0.9995	1.5630/1.5625	2.250/2.230	1.884/1.864	0.068	0.25
LBC-20	LBC-20-S	1.250	1,585	1.2500/1.2494	2.0008/2.0000	2.625/2.600	2.004/1.984	0.068	0.45
LBC-24	LBC-24-S	1.500	1,930	1.5000/1.4994	2.3760/2.3750	3.000/2.970	2.410/2.390	0.086	0.85
LBC-32	not available	2.000	3,000	2.0000/1.9992	3.0010/3.0000	4.000/3.960	3.193/3.163	0.105	1.45

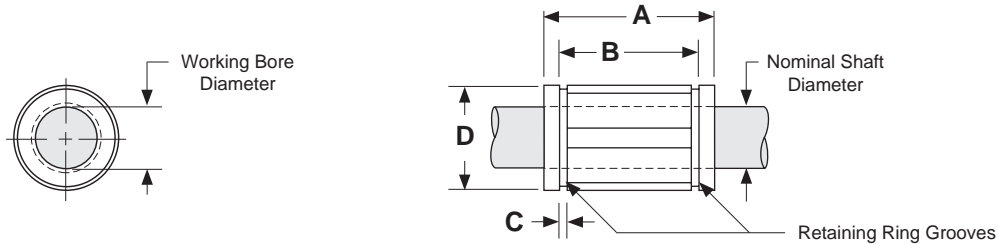

Dimensions & Specifications: **LBO** Linear Bearing (open)

Model Number		Nominal Shaft Diameter (inches)	Dyn. ⁽¹⁾ Load Capacity (lbs)	Working Bore Diameter (inches)	Housing Bore ⁽²⁾ D (inches)	Dimensions (inches)				Bearing Weight (lbs)
Without Seals	With Seals					A	B	C	E min.	
LBO-8	LBO-8-S	0.500	230	0.5000/0.4995	0.8755/0.8750	1.250/1.230	1.032/1.012	0.050	0.312	0.04
LBO-10	LBO-10-S	0.625	320	0.6250/0.6245	1.1255/1.1250	1.500/1.480	1.105/1.095	0.056	0.375	0.08
LBO-12	LBO-12-S	0.750	470	0.7500/0.7495	1.2505/1.2500	1.625/1.605	1.270/1.250	0.056	0.437	0.12
LBO-16	LBO-16-S	1.000	780	1.0000/0.9995	1.5630/1.5625	2.250/2.230	1.884/1.864	0.068	0.562	0.21
LBO-20	LBO-20-S	1.250	1,170	1.2500/1.2494	2.0008/2.0000	2.625/2.600	2.004/1.984	0.068	0.625	0.38
LBO-24	LBO-24-S	1.500	1,560	1.5000/1.4994	2.3760/2.3750	3.000/2.970	2.410/2.390	0.086	0.750	0.71
LBO-32	not available	2.000	2,350	2.0000/1.9992	3.0010/3.0000	4.000/3.960	3.193/3.163	0.105	1.000	1.20

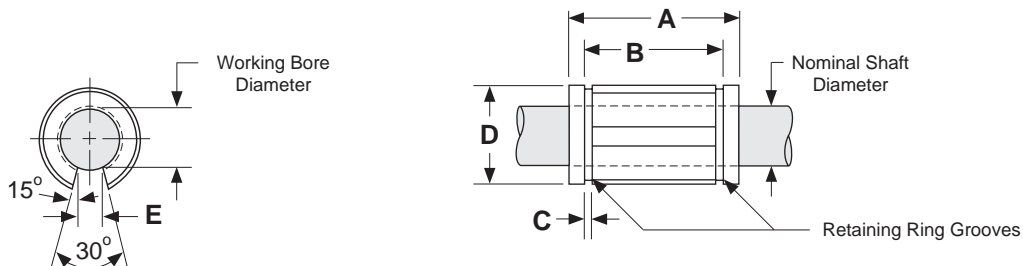

Footnotes:

- (1) Rating based upon 2 million inches of travel with the load forces being applied downward on the linear bearing, while in a horizontal application, and based upon 1060 steel shafting (Rockwell 60C). The actual load rating, and life, is dependent upon factors detailed on pages 6 to 11.
- (2) This specification is based upon the bearing being on the shaft. Refer to page 38 for additional details.



LBCM - **16** - **S**

Linear Bearing Closed Metric

LBCM - Asian Style Super Metric Bearing Closed

LBOM - Asian Style Super Metric Bearing Open

Nominal Diameter

16 - 16 mm diameter

30 - 30 mm diameter

20 - 20 mm diameter

40 - 40 mm diameter

25 - 25 mm diameter

Bearing Options

- No seals

S - Seals at both ends

Specifications: **LBCM** & **LBOM** Linear Bearings Metric (self-aligning)

Operating Temperature	-17.8° C to +85° C												
Maximum Speed	2,74 meters/second												
Matching Shaft	Metric (SM series), hardened & ground shafting (see pages 40 - 41)												
Housing Tolerances	<table border="1"> <thead> <tr> <th>Nominal Shaft Diameter (mm)</th> <th>Recommended Housing Bore D (mm)</th> </tr> </thead> <tbody> <tr> <td>16</td> <td>28,10 / 28,03</td> </tr> <tr> <td>20</td> <td>32,10 / 32,05</td> </tr> <tr> <td>25</td> <td>40,10 / 40,05</td> </tr> <tr> <td>30</td> <td>45,15 / 45,05</td> </tr> <tr> <td>40</td> <td>60,15 / 60,05</td> </tr> </tbody> </table>	Nominal Shaft Diameter (mm)	Recommended Housing Bore D (mm)	16	28,10 / 28,03	20	32,10 / 32,05	25	40,10 / 40,05	30	45,15 / 45,05	40	60,15 / 60,05
Nominal Shaft Diameter (mm)	Recommended Housing Bore D (mm)												
16	28,10 / 28,03												
20	32,10 / 32,05												
25	40,10 / 40,05												
30	45,15 / 45,05												
40	60,15 / 60,05												

Dimensions & Specifications: LBCM Linear Bearing Closed Metric (Asian Style)

Model Number		Nominal Shaft Diameter (mm)	Dynamic Load Capacity N (Kgf)	Housing Bore D (mm)	Dimensions (mm)			No. of Ball Tracks	Bearing Weight (kg)
Without Seals	With Seals				A	B	C		
LBCM-16	LBCM-16-S	16	1225 (119,9)	28	37	26,5	1,60	5	0,034
LBCM-20	LBCM-20-S	20	2303 (239,8)	32	42	30,5	1,60	6	0,058
LBCM-25	LBCM-25-S	25	4312 (459,6)	40	59	41,0	1,85	6	0,120
LBCM-30	LBCM-30-S	30	4802 (569,6)	45	64	44,5	1,85	6	0,148
LBCM-40	LBCM-40-S	40	9310 (949,3)	60	80	60,5	2,10	6	0,314

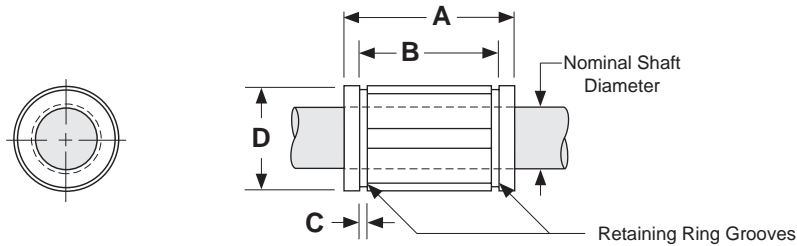

Dimensions & Specifications: LBOM Linear Bearing Open Metric (Asian Style)

Model Number		Nominal Shaft Diameter (mm)	Dynamic Load Capacity N (Kgf)	Housing Bore D (mm)	Dimensions (mm)				Angle α	No. of Ball Tracks	Bearing Weight (kg)
Without Seals	With Seals				A	B	C	E _{min.}			
LBOM-16	LBOM-16-S	16	1372 (139,9)	28	37	26,5	1,60	11,0	60 ⁰	4	0,026
LBOM-20	LBOM-20-S	20	2332 (237,8)	32	42	30,5	1,60	11,0	60 ⁰	5	0,048
LBOM-25	LBOM-25-S	25	4351 (443,7)	40	59	41,0	1,85	12,5	60 ⁰	5	0,100
LBOM-30	LBOM-30-S	30	4851 (494,7)	45	64	44,5	1,85	15,0	60 ⁰	5	0,122
LBOM-40	LBOM-40-S	40	9408 (959,3)	60	80	60,5	2,15	20,0	60 ⁰	5	0,260

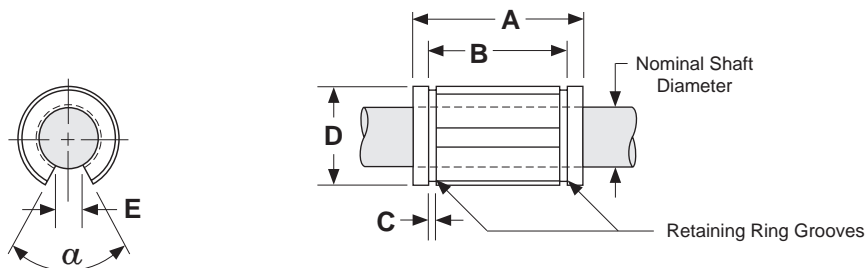

Footnotes:

- (1) Rating based upon 50 km of travel with the load forces being applied downward on the linear bearing, while in a horizontal application, and based upon 1060 steel shafting (Rockwell 60C).
- (2) This specification is based upon the bearing being on the shaft.

Ordering Guide - Self-Aligning Metric (European Style) - LBCME & LBOME Series



LBCME - **16** - **S**

Linear Bearing Closed Metric

LBCME - European ISO Super Metric Bearing Closed

LBOME - European ISO Super Metric Bearing Open

Nominal Diameter

16 - 16 mm diameter

20 - 20 mm diameter

25 - 25 mm diameter

30 - 30 mm diameter

40 - 40 mm diameter

50 - 50 mm diameter

Bearing Options

- No seals

S - Seals at both ends

Specifications: **LBCME** & **LBOME** Linear Bearings Metric (self-aligning)

Operating Temperature	-17.8° C to +85° C	
Maximum Speed	2,74 meters/second	
Matching Shaft	Metric (SM series), hardened & ground shafting (see pages 40 - 41)	
Housing Tolerances	Nominal Shaft Diameter	Recommended Housing Bore D
	(mm)	(mm)
	16	26,10 / 26,03
	20	32,10 / 32,05
	25	40,10 / 40,05
	30	47,15 / 47,05
40	62,15 / 62,05	
50	75,20 / 75,02	

Sold & Serviced By:

 **ELECTROMATE**

Toll Free Phone (877) SERV098

Toll Free Fax (877) SERV099

www.electromate.com

sales@electromate.com

Technical Reference - Self-Aligning Metric (European Style) - LBCME & LBOME Series

Dimensions & Specifications: **LBCME** Linear Bearing Closed Metric (European Style)

Model Number		Nominal Shaft Diameter (mm)	Dynamic Load Capacity N (Kgf)	Housing Bore D (mm)	Dimensions (mm)			No. of Ball Tracks	Bearing Weight (kg)
Without Seals	With Seals				A	B	C		
LBCME-16	LBCME-16-S	16	1176 (119,9)	26	36	24,6	1,30	5	0,026
LBCME-20	LBCME-20-S	20	2352 (239,8)	32	45	31,2	1,60	6	0,060
LBCME-25	LBCME-25-S	25	4508 (459,6)	40	58	43,7	1,85	6	0,120
LBCME-30	LBCME-30-S	30	5586 (569,6)	47	68	51,7	1,85	6	0,184
LBCME-40	LBCME-40-S	40	9310 (949,3)	62	80	60,3	2,15	6	0,342
LBCME-50	LBCME-50-S	50	13720 (1399,0)	75	100	77,3	2,65	6	0,586

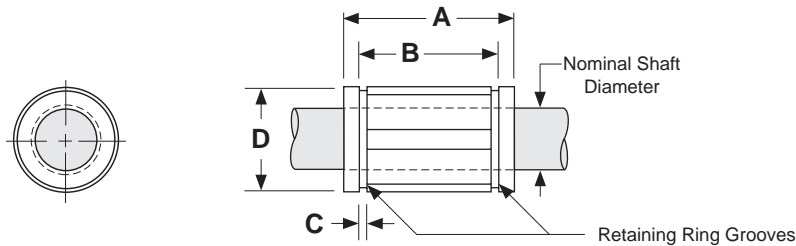

Dimensions & Specifications: **LBOME** Linear Bearing Open Metric (European Style)

Model Number		Nominal Shaft Diameter (mm)	Dynamic Load Capacity N (Kgf)	Housing Bore D (mm)	Dimensions (mm)				Angle α	No. of Ball Tracks	Bearing Weight (kg)
Without Seals	With Seals				A	B	C	E min.			
LBOME-16	LBOME-16-S	16	1332 (135,8)	26	36	24,6	1,30	9,0	4	0,020	
LBOME-20	LBOME-20-S	20	2371 (241,8)	32	45	31,2	1,60	9,0	5	0,050	
LBOME-25	LBOME-25-S	25	4557 (464,7)	40	58	43,7	1,85	11,5	5	0,100	
LBOME-30	LBOME-30-S	30	5644 (575,5)	47	68	51,7	1,85	14,0	5	0,154	
LBOME-40	LBOME-40-S	40	9398 (958,3)	62	80	60,3	2,15	19,5	5	0,286	
LBOME-50	LBOME-50-S	50	13857 (1413,0)	75	100	77,3	2,65	22,5	5	0,486	

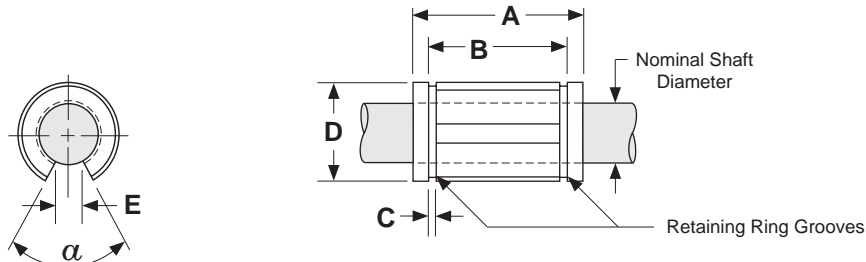

Footnotes:

- (1) Rating based upon 50 km of travel with the load forces being applied downward on the linear bearing, while in a horizontal application, and based upon 1060 steel shafting (Rockwell 60C).
- (2) This specification is based upon the bearing being on the shaft.

Sold & Serviced By:

ELECTROMATE

Toll Free Phone (877) SERV098

Toll Free Fax (877) SERV099

www.electromate.com

sales@electromate.com

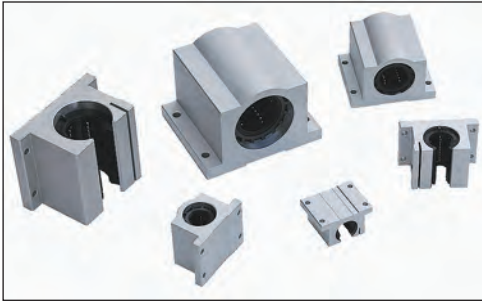

SLBC - **10** - **CR** - **L**

Pillow Block Series _____

- SLBC** - One LBC bearing per pillow block
- DLBC** - Two LBC bearings per pillow block
- SLBO** - One LBO bearing per pillow block
- DLBO** - Two LBO bearings per pillow block

Nominal Diameter _____

- 8** - 0.500 inch diameter
- 10** - 0.625 inch diameter
- 12** - 0.750 inch diameter
- 16** - 1.000 inch diameter
- 20** - 1.250 inch diameter
- 24** - 1.500 inch diameter
- 32** - 2.000 inch diameter (only in SLBC & SLBO style)

Bearing Options _____

- Standard
- CR** - Corrosion resistant

Bearing Lock _____

- None
- L** - Hand wheel lock

Specifications: **SLBC, SLBO, DLBC & DLBO** Pillow Blocks (self-aligning)

Bearing Housing Type & Finish	Aluminum 6061-T6 Pillow Block, Clear Anodized																	
Bearing Seals	Internal Wiper Seals on Both Ends																	
Operating Temperature	0° F to + 185° F																	
Maximum Speed	9 ft/second																	
Matching Shaft	Class L (SL series), hardened & ground shafting (see pages 38 - 39)																	
Diameter Tolerance	<table border="1"> <thead> <tr> <th>Nominal Shaft Diameter (inches)</th> <th>Shaft Diameter Tolerance (inches)</th> </tr> </thead> <tbody> <tr> <td>0.500</td> <td>.4995 / .4990</td> </tr> <tr> <td>0.625</td> <td>.6245 / .6240</td> </tr> <tr> <td>0.750</td> <td>.7495 / .7490</td> </tr> <tr> <td>1.000</td> <td>.9995 / .9990</td> </tr> <tr> <td>1.250</td> <td>1.2495 / 1.2490</td> </tr> <tr> <td>1.500</td> <td>1.4994 / 1.4989</td> </tr> <tr> <td>2.000</td> <td>1.9994 / 1.9987</td> </tr> </tbody> </table>	Nominal Shaft Diameter (inches)	Shaft Diameter Tolerance (inches)	0.500	.4995 / .4990	0.625	.6245 / .6240	0.750	.7495 / .7490	1.000	.9995 / .9990	1.250	1.2495 / 1.2490	1.500	1.4994 / 1.4989	2.000	1.9994 / 1.9987	
Nominal Shaft Diameter (inches)	Shaft Diameter Tolerance (inches)																	
0.500	.4995 / .4990																	
0.625	.6245 / .6240																	
0.750	.7495 / .7490																	
1.000	.9995 / .9990																	
1.250	1.2495 / 1.2490																	
1.500	1.4994 / 1.4989																	
2.000	1.9994 / 1.9987																	

Dimensions & Specifications: **SLBC** Single Linear Bearing Closed Pillow Block (self-aligning)

Model Number	Nominal Shaft Diameter (inches)	Dyn. Load Capacity (lbs)	Dimensions (inches)											Block Weight (lbs)
			A	B	C	D	E	F	G	H	I	J		
			+/- .003				+/- .010	+/- .010				hole	bolt	
SLBC-8	0.500	265	0.687	2.00	1.69	1.13	1.688	1.000	1.38	1.25	.25	.16	# 6	0.20
SLBC-10	0.625	420	0.875	2.50	1.94	1.44	2.125	1.125	1.75	1.63	.28	.19	# 8	0.50
SLBC-12	0.750	640	0.937	2.75	2.06	1.56	2.375	1.250	1.88	1.75	.31	.19	# 8	0.60
SLBC-16	1.000	1,045	1.187	3.25	2.81	1.94	2.875	1.750	2.38	2.19	.38	.22	#10	1.20
SLBC-20	1.250	1,585	1.500	4.00	3.63	2.50	3.500	2.000	3.00	2.81	.44	.22	#10	2.50
SLBC-24	1.500	1,930	1.750	4.75	4.00	2.88	4.125	2.500	3.50	3.25	.50	.28	1/4	3.80
SLBC-32	2.000	3,000	2.125	6.00	5.00	3.63	5.250	3.250	4.50	4.06	.63	.41	3/8	7.00

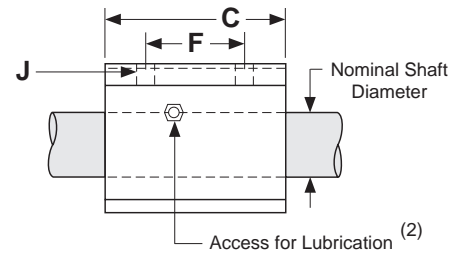
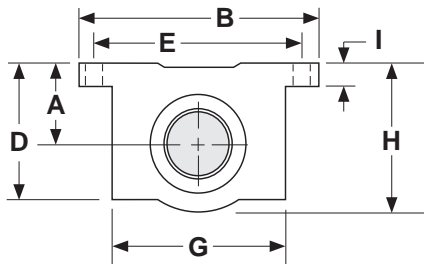

Dimensions & Specifications: **SLBO** Single Linear Bearing Open Pillow Block (self-aligning)

Model Number	Nominal Shaft Diameter (inches)	Dyn. Load Capacity (lbs)	Dimensions (inches)													Block Weight (lbs)
			A	B	C	D	E	F	G	H		I	J	K		
			+/- .003				+/- .010	+/- .010		hole	bolt		min.			
SLBO-8	0.500	230	0.687	2.00	1.50	1.13	1.688	1.000	0.69	.16	# 6	.25	0.31	0.75	0.20	
SLBO-10	0.625	320	0.875	2.50	1.75	1.44	2.125	1.125	0.88	.19	# 8	.28	0.37	0.94	0.40	
SLBO-12	0.750	470	0.937	2.75	1.88	1.56	2.375	1.250	0.94	.19	# 8	.31	0.43	1.00	0.50	
SLBO-16	1.000	780	1.187	3.25	2.63	2.00	2.875	1.750	1.19	.22	#10	.38	0.56	1.25	1.00	
SLBO-20	1.250	1,170	1.500	4.00	3.38	2.56	3.500	2.000	1.50	.22	#10	.44	0.62	1.63	2.10	
SLBO-24	1.500	1,560	1.750	4.75	3.75	2.94	4.125	2.500	1.75	.28	1/4	.50	0.75	1.88	3.20	
SLBO-32	2.000	2,350	2.125	6.00	4.75	3.63	5.250	3.250	2.25	.41	3/8	.63	1.00	2.44	6.00	

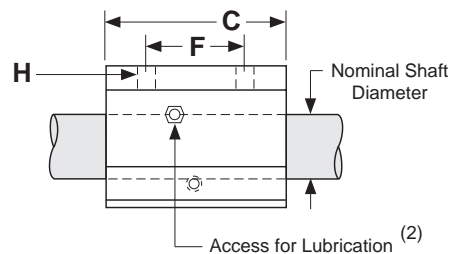
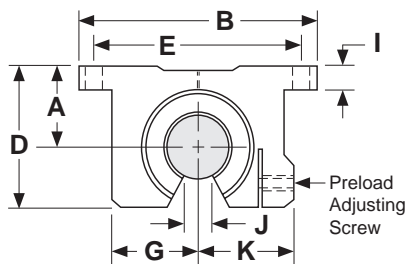

Footnotes:

- (1) Rating based upon 2 million inches of travel with the load forces being applied downward on the linear bearing, while in a horizontal application, and based upon 1060 steel shafting (Rockwell 60C). The actual load rating, and life, is dependent upon factors detailed on pages 6 to 11.
- (2) Size 0.500 has oil lubricant fitting. Sizes 0.625 and above have a 1/4-28 UNF straight thread access for lubrication.

Dimensions & Specifications: DLBC Double Linear Bearing Closed Pillow Block (self-aligning)

Model Number	Nominal Shaft Diameter (inches)	Dyn. Load Capacity (lbs) ⁽¹⁾	Dimensions (inches)											Block Weight (lbs)	
			A	B	C	D	E	F	G	H	I	J			d ₂ ⁽³⁾
			+/- .003				+/- .010	+/- .010					hole		
DLBC-8	0.500	510	0.687	2.00	3.50	1.13	1.688	2.500	1.38	1.25	.25	.16	# 6	1.75	0.40
DLBC-10	0.625	900	0.875	2.50	4.00	1.44	2.125	3.000	1.75	1.63	.28	.19	# 8	2.00	1.00
DLBC-12	0.750	1,200	0.937	2.75	4.50	1.56	2.375	3.500	1.88	1.75	.31	.19	# 8	2.25	1.20
DLBC-16	1.000	2,100	1.187	3.25	6.00	1.94	2.875	4.500	2.38	2.19	.38	.22	#10	3.00	2.40
DLBC-20	1.250	3,000	1.500	4.00	7.50	2.50	3.500	5.500	3.00	2.81	.44	.22	#10	3.75	5.00
DLBC-24	1.500	4,000	1.750	4.75	9.00	2.88	4.125	6.500	3.50	3.25	.50	.28	1/4	4.50	7.80

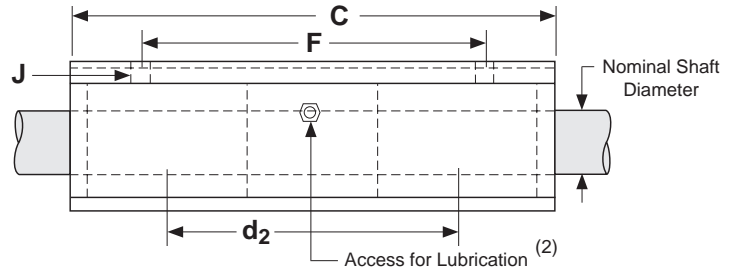
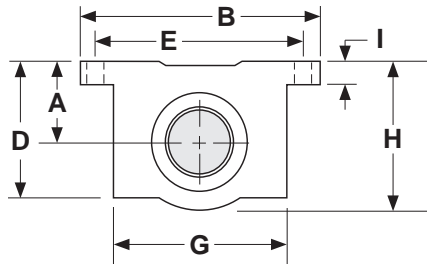

Dimensions & Specifications: DLBO Double Linear Bearing Pillow Block Open (self-aligning)

Model Number	Nominal Shaft Diameter (inches)	Dyn. Load Capacity (lbs) ⁽¹⁾	Dimensions (inches)													Block Weight (lbs)
			A	B	C	D	E	F	G	H	I	J		K	d ₂ ⁽³⁾	
			+/- .003				+/- .010	+/- .010		min.		hole	bolt			
DLBO-8	0.500	460	0.687	2.00	3.50	1.13	1.688	2.500	0.69	.31	.25	.16	# 6	0.75	1.75	0.40
DLBO-10	0.625	640	0.875	2.50	4.00	1.44	2.125	3.000	0.88	.37	.28	.19	# 8	0.94	2.00	0.80
DLBO-12	0.750	940	0.937	2.75	4.50	1.56	2.375	3.500	0.94	.43	.31	.19	# 8	1.00	2.25	1.00
DLBO-16	1.000	1,560	1.187	3.25	6.00	2.00	2.875	4.500	1.19	.56	.38	.22	#10	1.25	3.00	2.00
DLBO-20	1.250	2,340	1.500	4.00	7.50	2.56	3.500	5.500	1.50	.62	.44	.22	#10	1.63	3.75	4.20
DLBO-24	1.500	3,120	1.750	4.75	9.00	2.94	4.125	6.500	1.75	.75	.50	.28	1/4	1.88	4.50	6.70

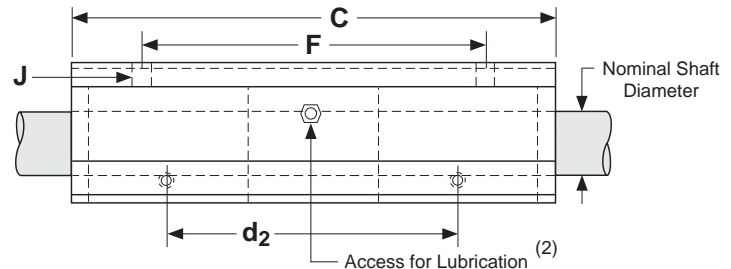
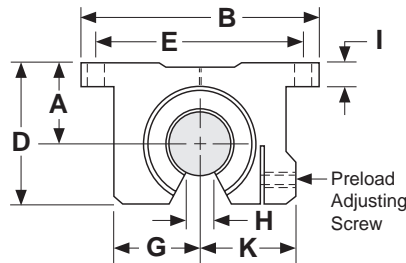

Footnotes:

- (1) Rating based upon 2 million inches of travel with the load forces being applied downward on the linear bearing, while in a horizontal application, and based upon 1060 steel shafting (Rockwell 60C). The actual load rating, and life, is dependent upon factors detailed on pages 6 to 11.
- (2) Size 0.500 has oil lubricant fitting. Sizes 0.625 and above have a 1/4-28 UNF straight thread access for lubrication.
- (3) This value is the center to center distance (spacing) of the bearings on a single shaft (d₂).

Sold & Serviced By:

ELECTROMATE

Toll Free Phone (877) SERV098

Toll Free Fax (877) SERV099

www.electromate.com

sales@electromate.com

Specifications subject to change without notice

TRCA - **12** - **12** - **CR** - **P** - **L1**

TWIN RAIL® Carriage Assembly series

TRCA - Plate with mounted SLBO or DLBO

Nominal Bearing Diameter

- 8** - 0.500 inch diameter
- 10** - 0.625 inch diameter
- 12** - 0.750 inch diameter
- 16** - 1.000 inch diameter
- 20** - 1.250 inch diameter
- 24** - 1.500 inch diameter
- 32** - 2.000 inch diameter

Carriage Plate Length

- 6** - 6 inches
- 8** - 8 inches
- 12** - 12 inches
- 18** - 18 inches
- 24** - 24 inches
- 30** - 30 inches

Bearing Options

- Standard
- CR** - Corrosion resistant

Carriage Plate Mounting

- No Holes
- P** - Pre-Machined Mounting holes

Bearing Lock

- None
- Lx** - Hand wheel locks (x = number of locks - 1, 2, 3 or 4)

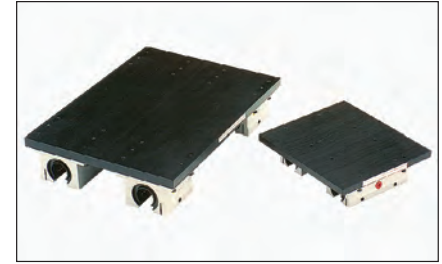

Specifications: TRCA TWIN RAIL® Carriage Assembly

Bearing Housing Type & Finish	Aluminum 6061-T6 Pillow Block, Clear Anodized																	
Bearing Seals	Internal Wiper Seals on Both Ends																	
Carriage Plate Type & Finish	Machined Aluminum 6061-T6 Plate, Black Anodized																	
Bearing Alignment on Plate	+/- 0.001", Pillow Blocks Doweled to Carriage Plate																	
Operating Temperature	0° F to + 185° F																	
Maximum Speed	9 ft/second																	
Matching Shaft Assembly	TRSA series (see page 47)																	
Diameter Tolerance	<table border="1"> <thead> <tr> <th>Nominal Shaft Diameter (inches)</th> <th>Shaft Diameter Tolerance (inches)</th> </tr> </thead> <tbody> <tr> <td>0.500</td> <td>.4995 / .4990</td> </tr> <tr> <td>0.625</td> <td>.6245 / .6240</td> </tr> <tr> <td>0.750</td> <td>.7495 / .7490</td> </tr> <tr> <td>1.000</td> <td>.9995 / .9990</td> </tr> <tr> <td>1.250</td> <td>1.2495 / 1.2490</td> </tr> <tr> <td>1.500</td> <td>1.4994 / 1.4989</td> </tr> <tr> <td>2.000</td> <td>1.9994 / 1.9987</td> </tr> </tbody> </table>	Nominal Shaft Diameter (inches)	Shaft Diameter Tolerance (inches)	0.500	.4995 / .4990	0.625	.6245 / .6240	0.750	.7495 / .7490	1.000	.9995 / .9990	1.250	1.2495 / 1.2490	1.500	1.4994 / 1.4989	2.000	1.9994 / 1.9987	
Nominal Shaft Diameter (inches)	Shaft Diameter Tolerance (inches)																	
0.500	.4995 / .4990																	
0.625	.6245 / .6240																	
0.750	.7495 / .7490																	
1.000	.9995 / .9990																	
1.250	1.2495 / 1.2490																	
1.500	1.4994 / 1.4989																	
2.000	1.9994 / 1.9987																	

Dimensions & Specifications: TRCA TWIN RAIL® Carriage Assembly

Model Number	Nom. Shaft Dia. (inches)	Dyn. Load Cap. (lbs)	Dimensions (inches)													Assembly Weight (lbs)
			A +/- .005	B +/- .005	C	D	E	F	G	H	J	K	d _r ⁽²⁾	d ₁ ⁽³⁾	d ₂ ⁽⁴⁾	
TRCA8-6	0.500	920	6.00	5.50	1.25	0.75	0.68	1.12	2.00	.25	3.50	0.375	1.062	3.00	1.90	2.4
TRCA8-12	0.500	920	12.00	5.50	0.25	0.75	0.68	1.12	2.00	.25	11.50	0.375	1.062	3.00	10.00	4.6
TRCA8-18	0.500	920	18.00	5.50	0.25	0.75	0.68	1.12	2.00	.25	17.50	0.375	1.062	3.00	16.00	5.9
TRCA10-6	0.625	1,280	6.00	6.75	1.00	0.93	0.87	1.43	2.50	.25	4.00	0.375	1.250	3.75	2.15	3.5
TRCA10-12	0.625	1,280	12.00	6.75	0.25	0.93	0.87	1.43	2.50	.25	11.50	0.375	1.250	3.75	9.75	6.0
TRCA10-18	0.625	1,280	18.00	6.75	0.25	0.93	0.87	1.43	2.50	.25	17.50	0.375	1.250	3.75	15.75	7.7
TRCA12-6	0.750	1,880	6.00	7.75	0.75	1.00	0.93	1.56	2.75	.25	4.50	0.500	1.437	4.50	2.50	4.8
TRCA12-12	0.750	1,880	12.00	7.75	0.25	1.00	0.93	1.56	2.75	.25	11.49	0.500	1.437	4.50	9.62	8.2
TRCA12-18	0.750	1,880	18.00	7.75	0.25	1.00	0.93	1.56	2.75	.25	17.49	0.500	1.437	4.50	15.62	10.7
TRCA16-6	1.000	3,120	6.00	9.00	0.00	1.25	1.18	2.00	3.25	.25	6.00	0.500	1.687	5.25	3.25	7.2
TRCA16-12	1.000	3,120	12.00	9.00	0.25	1.25	1.18	2.00	3.25	.25	11.49	0.500	1.687	5.25	8.87	11.0
TRCA16-18	1.000	3,120	18.00	9.00	0.25	1.25	1.18	2.00	3.25	.25	17.49	0.500	1.687	5.25	14.87	14.0
TRCA16-24	1.000	3,120	24.00	9.00	0.25	1.25	1.18	2.00	3.25	.25	23.49	0.500	1.687	5.25	20.87	16.9
TRCA20-8	1.250	4,680	8.00	10.50	0.25	1.62	1.50	2.56	4.00	.25	7.50	0.750	2.250	6.00	3.90	16.0
TRCA20-12	1.250	4,680	12.00	10.50	0.25	1.62	1.50	2.56	4.00	.25	11.49	0.750	2.250	6.00	8.12	16.4
TRCA20-18	1.250	4,680	18.00	10.50	0.25	1.62	1.50	2.56	4.00	.25	17.49	0.750	2.250	6.00	14.12	21.6
TRCA20-24	1.250	4,680	24.00	10.50	0.25	1.62	1.50	2.56	4.00	.25	23.49	0.750	2.250	6.00	20.12	26.8
TRCA24-12	1.500	6,240	12.00	12.00	1.50	1.87	1.75	2.93	4.75	.31	9.00	1.000	2.750	6.62	5.00	30.0
TRCA24-18	1.500	6,240	18.00	12.00	0.25	1.87	1.75	2.93	4.75	.31	17.50	1.000	2.750	6.62	13.75	40.2
TRCA24-24	1.500	6,240	24.00	12.00	0.25	1.87	1.75	2.93	4.75	.31	23.50	1.000	2.750	6.62	19.75	48.1
TRCA24-30	1.500	6,240	30.00	12.00	0.25	1.87	1.75	2.93	4.75	.31	29.50	1.000	2.750	6.62	25.75	56.0
TRCA32-18	2.000	9,400	18.00	14.00	0.25	2.43	2.25	3.62	6.00	.37	17.50	1.250	3.375	7.25	12.75	61.7
TRCA32-24	2.000	9,400	24.00	14.00	0.25	2.43	2.25	3.62	6.00	.37	23.50	1.250	3.375	7.25	18.75	73.2
TRCA32-30	2.000	9,400	30.00	14.00	0.25	2.43	2.25	3.62	6.00	.37	29.50	1.250	3.375	7.25	24.75	84.8

Footnotes:

- (1) Rating based upon 2 million inches of travel with the load forces being applied downward on the linear bearing, while in a horizontal application, and based upon 1060 steel shafting (Rockwell 60C). The actual load rating, and life, is dependent upon factors detailed on pages 6 to 11.
- (2) This value is the center distance of the bearing to the top of the carriage plate surface (d_r).
- (3) This value is the center to center distance (spread) between the rails (d₁).
- (4) This value is the center to center distance (spacing) of the bearings on a single shaft (d₂).

Dimensions

(inches)

Available For:

TRCA8-6, TRCA10-6, TRCA12-6,
TRCA16-6, TRCA20-8, TRCA24-12

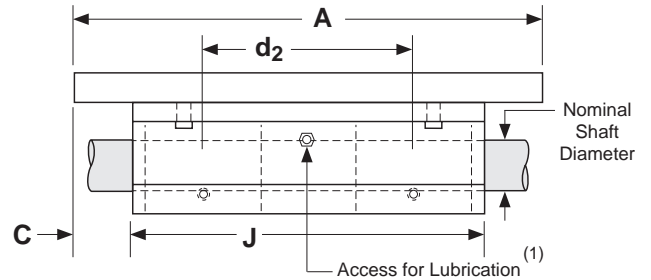
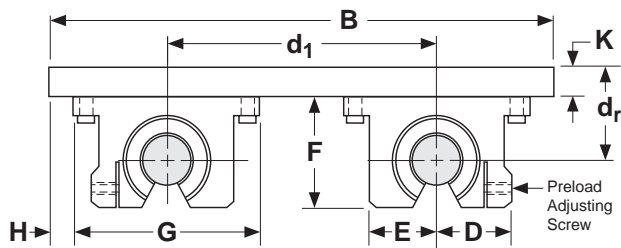

Available For:

All other TRCA models,
not shown above

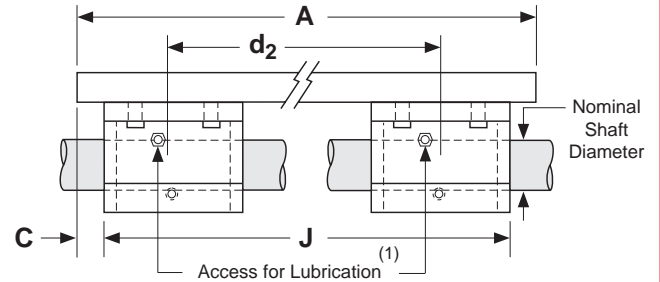
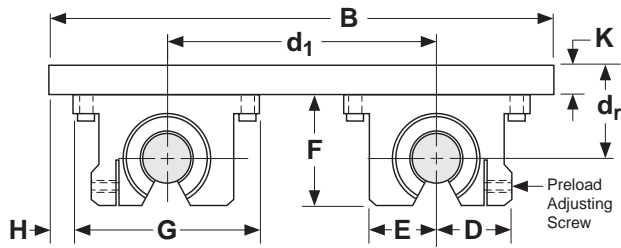

Footnotes:

(1) Size 0.500 has oil lubricant fitting. Sizes 0.625 and above have a $1/4$ -28 UNF straight thread access for lubrication.

(-P) Pre-Machined Carriage Mounting Holes

All carriage assembly plates are available with a pre-determined number & location of mounting holes. These holes consist of stainless steel threaded inserts per the below chart. Custom mounting patterns are available upon request.

Model Number	Carriage Length (inches)	L (inches)	Threaded Insert Size
TRCA8-6-P	6.00	5.00	#10-32
TRCA8-12-P	12.00	5.00	#10-32
TRCA8-18-P	18.00	5.00	#10-32
TRCA10-6-P	6.00	5.00	#10-32
TRCA10-12-P	12.00	5.00	#10-32
TRCA10-18-P	18.00	5.50	#10-32
TRCA12-6-P	6.00	5.00	1/4-28
TRCA12-12-P	12.00	5.00	1/4-28
TRCA12-18-P	18.00	5.50	1/4-28
TRCA16-6-P	6.00	5.00	5/16-24
TRCA16-12-P	12.00	5.00	5/16-24
TRCA16-18-P	18.00	5.00 </td <td>5/16-24</td>	5/16-24
TRCA16-24-P	24.00	5.00	5/16-24
TRCA20-8-P	8.00	7.00	3/8-24
TRCA20-12-P	12.00	5.00	3/8-24
TRCA20-18-P	18.00	5.00	3/8-24
TRCA20-24-P	24.00	5.00	3/8-24
TRCA24-12-P	12.00	5.00	3/8-24
TRCA24-18-P	18.00	5.00	3/8-24
TRCA24-24-P	24.00	5.00	3/8-24
TRCA24-30-P	30.00	5.25	3/8-24
TRCA32-18-P	18.00	5.00	1/2-20
TRCA32-24-P	24.00	5.00	1/2-20
TRCA32-30-P	30.00	5.25	1/2-20

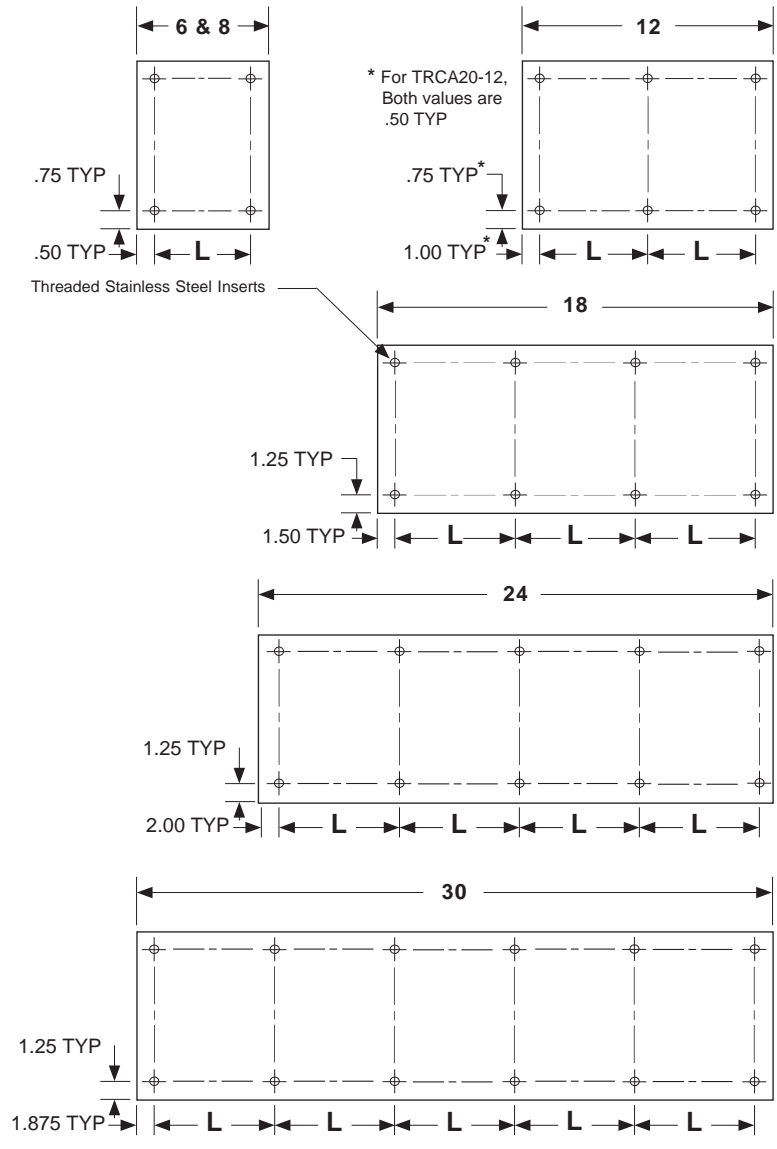

Options

(-L) Hand Wheel Lock

This option adds an aluminum clamping block to the end of a pillow block, which then provides for a manual lock of the bearing to the shaft. The threaded hand wheel shaft presses into a bronze insert which makes contact to provide a "pressure lock" to the shaft. The threaded steel screw will not back drive and does not make physical contact with the steel shaft (no steel to steel contact). The lock will be installed as shown below when ordered with a SLBC, SLBO, DLBC, DLBO, or TRCA series. Multiple locks can be installed onto a TRCA assembly.

Nominal Shaft Diameter (inches)	Dimensions (inches)						
	A	B	C	D	E		F
					open	closed	
8 - 0.500	1.680	1.72	2.00	0.50	.56	.44	2.00
10 - 0.625	1.875	1.53	2.00	0.50	.50	.31	2.50
12 - 0.750	2.067	1.46	2.00	0.50	.37	.18	2.75
16 - 1.000	2.312	1.34	2.00	0.50	.19	---	3.25
20 - 1.250	3.125	1.66	2.50	0.75	.17	---	4.00
24 - 1.500	3.625	1.46	2.50	0.75	.05	---	4.75
32 - 2.000	4.600	1.45	2.50	0.75	---	---	6.00

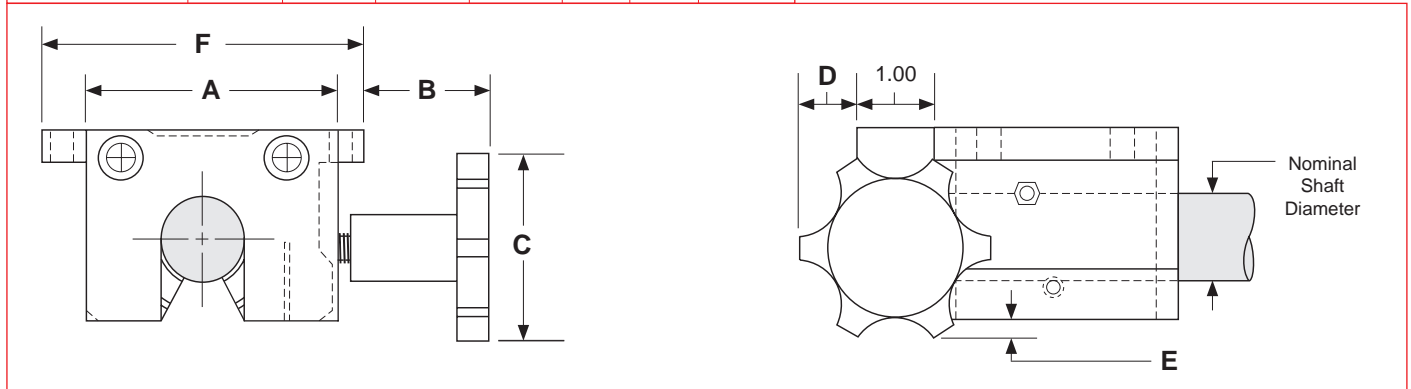

Custom Carriage Sizes

Custom carriage sizes that need to be wider, or longer than shown in this catalog can be provided upon request. This will allow for larger rail and bearing spacing (d_1 & d_2 dimensions).

Custom Carriage Material & Finishes

The standard carriage material is aluminum with a black anodized finish. Aluminum plates can be finished in many different colors, while steel carriage plates can be provided with a black oxide finish. Many other custom alternatives for carriage plates are available.

Special Grease Options

Bearings can be supplied with special greases, or lubricants, in order to meet the environmental requirements of the application. Examples of operating environments which may require a special lubricant include: high or low temperature, clean rooms, vacuums and food grade applications.

SLBCM Series

Single Self-Aligning Closed

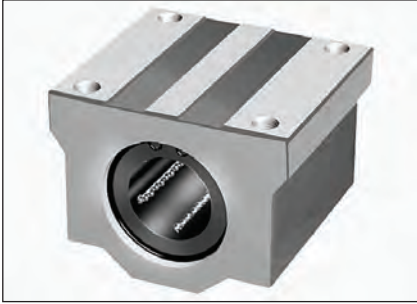

SLBCM-A Series

Single Self-Aligning Closed Adjustable

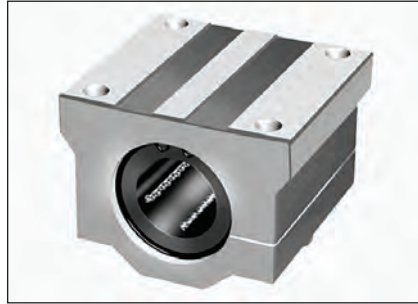

SLBOM Series

Single Self-Aligning Open



DLBCM Series

Double Self-Aligning Closed



SLBCME Series

Single Self-Aligning Closed



SLBCME-A Series

Single Self-Aligning Closed Adjustable



SLBOME Series

Single Self-Aligning Open



SLBOME-A Series

Single Self-Aligning Open Adjustable



DLBCME Series

Double Self-Aligning Closed



DLBCME-A Series

Single Self-Aligning Closed Adjustable



DLBOME Series

Double Self-Aligning Open



DLBOME-A Series

Double Self-Aligning Open Adjustable



Sold & Serviced By:

 **ELECTROMATE**

Toll Free Phone (877) SERV098

Toll Free Fax (877) SERV099

www.electromate.com

sales@electromate.com

Notes

Shafting, Shaft Supports and Shaft Assembly Products

Precision Linear Shafting _____	38 - 41
Shaft Supports _____	42 - 45
SA series _____	48 - 55
TRSA series _____	56 - 63
Options _____	64 - 65

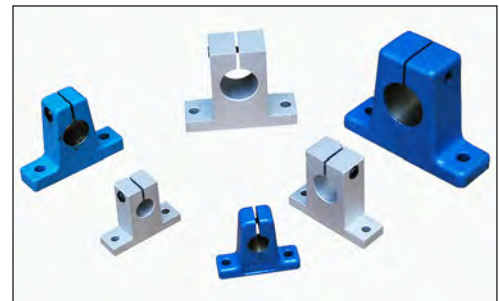

Sold & Serviced By:

 **ELECTROMATE**

Toll Free Phone (877) SERV098

Toll Free Fax (877) SERV099

www.electromate.com

sales@electromate.com



SL **12** - **SS** - **PD** x **105.375**

Shafting _____

- SL** - Class L diameter tolerance
- SS** - Class S diameter tolerance
- SN** - Class N diameter tolerance

Shaft Diameter _____

- 4** - 0.250 inch diameter
- 6** - 0.375 inch diameter
- 8** - 0.500 inch diameter
- 10** - 0.625 inch diameter
- 12** - 0.750 inch diameter
- 16** - 1.000 inch diameter
- 20** - 1.250 inch diameter
- 24** - 1.500 inch diameter
- 32** - 2.000 inch diameter

Shaft Material _____

- 1060 Steel
- SS** - 440C Stainless Steel (not available in class N)
- CR** - Chrome Plated 1060 Steel

Pre-Drilled _____

- No mounting hole pattern
- PD** - pre-drilled hole pattern

Overall Length _____

xxx.xxx - inches for all series

Specifications: SL, SS & SN Inch Precision Shafting

Shaft Straightness⁽¹⁾	0.001/0.002 in/ft, cumulative				
Shaft Type	1060 Steel or 440C Stainless steel (only with L & S tolerance)				
Shaft Roundness	0.000080 inches				
Shaft Chamfer	For 0.25 - 0.75 inch dia. : 0.03 inch x 45°, For 1.00 - 2.00 inch dia. : 0.06 inch x 45°				
Surface Finish	8 - 12 R _a microinch				
Diameter Tolerance	Nominal Shaft Diameter (inches)	Class L Diameter Tolerance (inches)	Class S Diameter Tolerance (inches)	Class N Diameter Tolerance (inches)	Minimum Hardness Depth (inches)
Hardness Depth	0.250	.2495 / .2490	.2490 / .2485	.2500 / .2498	0.040
	0.375	.3745 / .3740	.3740 / .3735	.3750 / .3748	0.040
	0.500	.4995 / .4990	.4990 / .4985	.5000 / .4998	0.040
	0.625	.6245 / .6240	.6240 / .6235	.6250 / .6248	0.040
	0.750	.7495 / .7490	.7490 / .7485	.7500 / .7498	0.060
	1.000	.9995 / .9990	.9990 / .9985	1.0000 / .9998	0.080
	1.250	1.2495 / 1.2490	1.2490 / 1.2485	1.2500 / 1.2498	0.080
	1.500	1.4994 / 1.4989	1.4989 / 1.4984	1.5000 / 1.4997	0.080
	2.000	1.9994 / 1.9987	1.9987 / 1.9980	2.0000 / 1.9997	0.100

Footnotes:

(1) Straightness of .0005/.001 in/ft cumulative is available. Contact the factory.

Dimensions & Specifications: SL, SS & SN Inch Precision Shafting

Model Number	Nominal Shaft Diameter (inches)	Maximum Length				Shaft Weight (lbs/in)	
		Class L -SS (inches)		Class S -SS (inches)			Class N (inches)
Sx4	0.250	96	144	96	144	96	0.014
Sx6	0.375	172	154	172	154	172	0.031
Sx8	0.500	184	154	184	154	184	0.055
Sx10	0.625	184	154	184	154	184	0.086
Sx12	0.750	184	154	184	154	184	0.125
Sx16	1.000	184	154	184	154	184	0.222
Sx20	1.250	184	154	184	154	184	0.348
Sx24	1.500	184	154	184	154	184	0.500
Sx32	2.000	184	154	184	154	184	0.890

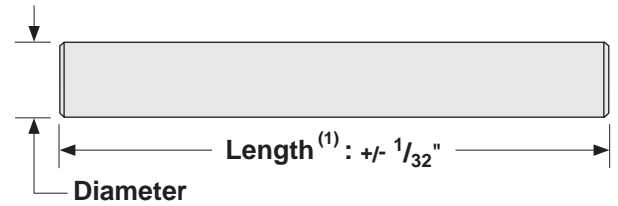

Dimensions & Specifications: SL-PD Inch Precision Shafting

Model Number	Nominal Shaft Diameter (inches)	Maximum Length (inches)		Pre-Drilled Holes (inches)			Shaft Weight (lbs/in)
		-SS (inches)		A +/- .016	B	G	
SL8-PD	0.500	172	154	2.00	4.00	#6-32	0.055
SL10-PD	0.625	184	154	2.00	4.00	#8-32	0.086
SL12-PD	0.750	184	154	3.00	6.00	#10-32	0.125
SL16-PD	1.000	184	154	3.00	6.00	1/4-20	0.222
SL20-PD	1.250	184	154	3.00	6.00	5/16-18	0.348
SL24-PD	1.500	184	154	4.00	8.00	3/8-16	0.500
SL32-PD	2.000	184	154	4.00	8.00	1/2-13	0.890

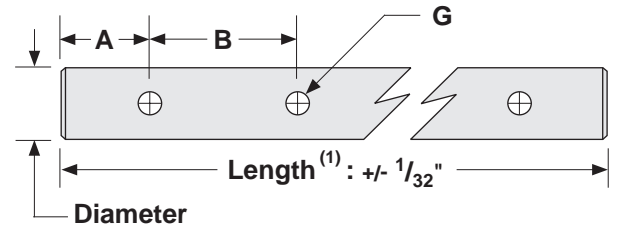

Footnotes:

(1) Length tolerance for 2" diameter shafting is +/- 1/16 inches. Tighter tolerance available. Contact the factory.



SM 12 - CR x 105.375

Shafting _____

SM - Metric diameter

Shaft Diameter _____

8 - 8 mm diameter
10 - 10 mm diameter
12 - 12 mm diameter
16 - 16 mm diameter
20 - 20 mm diameter
25 - 25 mm diameter
30 - 30 mm diameter
40 - 40 mm diameter
50 - 50 mm diameter

Shaft Material _____

- 1060 Steel
CR - Chrome Plated 1060 Steel

Overall Length _____

xxx.xxx - inches for all series

Specifications: **SM** Metric Precision Shafting

Shaft Straightness	0,0254/0,0508 mm/300 mm - cumulative		
Shaft Type	1060 Steel		
Shaft Roundness	0,0020 mm		
Shaft Chamfer	For 8 - 20 mm dia. : 0,762 mm x 45°, For 25 - 50 mm dia. : 1,524 mm inch x 45°		
Surface Finish	8 - 12 R _a microinch		
Diameter Tolerance	Nominal Shaft Diameter	Diameter Tolerance	Minimum Hardness Depth
Hardness Depth	(mm)	(mm)	(mm)
	8	8,00 / 7,99	1,02
	10	10,00 / 9,99	1,02
	12	12,00 / 11,99	1,52
	16	16,00 / 15,99	1,52
	20	20,00 / 19,99	1,52
	25	25,00 / 24,99	2,03
	30	30,00 / 29,99	2,03
	40	40,00 / 39,99	2,03
	50	50,00 / 49,98	2,54

Dimensions & Specifications: **SM** Metric Precision Shafting

Model Number	Nominal Shaft Diameter (mm)	Maximum Length inches (mm)	Shaft Weight (lbs/in)
SM8	8	172 (4368,8)	0.022
SM10	10	172 (4368,8)	0.038
SM12	12	184 (4673,6)	0.050
SM16	16	184 (4673,6)	0.088
SM20	20	184 (4673,6)	0.138
SM25	25	184 (4673,6)	0.216
SM30	30	184 (4673,6)	0.311
SM40	40	184 (4673,6)	0.553
SM50	50	184 (4673,6)	0.864

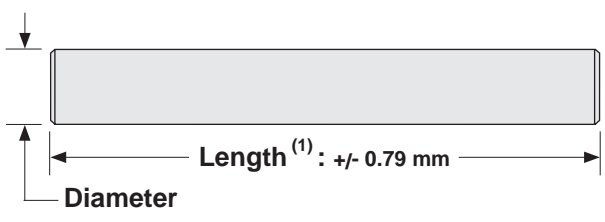

(1) Tighter tolerance available. Contact the factory.

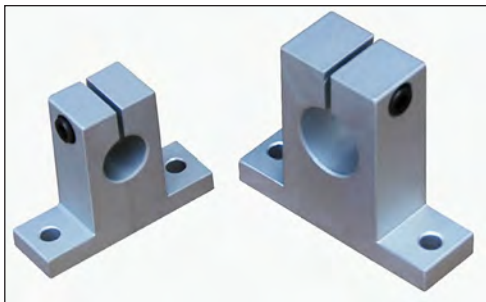

ES 10 - A

End Support Block _____

Shaft Diameter _____

- 8** - 0.500 inch diameter
- 12** - 0.750 inch diameter
- 16** - 1.000 inch diameter
- 20** - 1.250 inch diameter
- 24** - 1.500 inch diameter
- 32** - 2.000 inch diameter

Support Material _____

- A** - Aluminum

Dimensions & Specifications: **ES-A** End Shaft Support Block

Model Number	Nominal Shaft Diameter (inches)	Dimensions (inches)									Support Weight (lbs)
		A +/- .001	B	C	D	E +/- .010	F	H	M		
									hole	bolt size	
ES8-A	0.500	1.000	2.000	0.875	.250	1.500	0.625	1.625	.188	#8	.08
ES12-A	0.750	1.250	2.500	1.250	.313	2.000	0.750	2.063	.218	#10	.16
ES16-A	1.000	1.500	3.063	1.500	.375	2.500	1.000	2.500	.281	1/4	.30
ES20-A	1.250	1.750	3.750	2.000	.438	3.000	1.125	3.000	.346	5/16	.53
ES24-A	1.500	2.000	4.375	2.250	.500	3.500	1.250	3.437	.346	5/16	.73
ES32-A	2.000	2.500	5.500	3.000	.625	4.500	1.500	4.500	.406	3/8	1.40

Material: 6061-T6 aluminum
Finish: natural finish

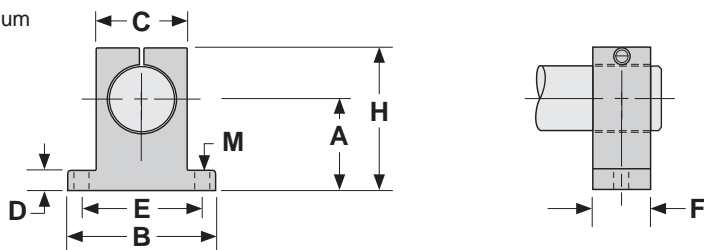

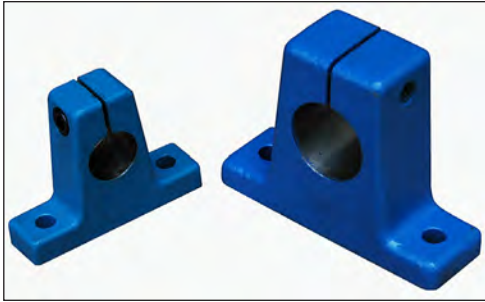

ES 10 - S

End Support Block _____

Shaft Diameter _____

- 8** - 0.500 inch diameter
- 10** - 0.625 inch diameter
- 12** - 0.750 inch diameter
- 16** - 1.000 inch diameter
- 20** - 1.250 inch diameter
- 24** - 1.500 inch diameter
- 32** - 2.000 inch diameter

Support Material _____

S - Steel

Dimensions & Specifications: **ES-S** End Shaft Support Block

Model Number	Nominal Shaft Diameter (inches)	Dimensions (inches)									Support Weight (lbs)
		A +/- .001	B	C	D	E +/- .010	F	H	M		
									hole	bolt size	
ES8-S	0.500	1.000	2.000	0.750	.250	1.500	0.625	1.625	.218	#10	.28
ES10-S	0.625	1.000	2.500	0.875	.312	1.875	0.750	1.750	.218	#10	.36
ES12-S	0.750	1.250	2.750	1.000	.375	2.000	0.750	2.125	.281	1/4	.53
ES16-S	1.000	1.500	3.312	1.375	.375	2.500	1.000	2.625	.281	1/4	1.00
ES20-S	1.250	1.750	4.000	1.750	.438	3.000	1.250	3.000	.343	5/16	2.10
ES24-S	1.500	2.000	4.750	2.000	.500	3.500	1.250	3.500	.343	5/16	2.80
ES32-S	2.000	2.500	6.000	2.625	.625	4.500	1.500	4.500	.406	3/8	5.10

Material: C1045 steel
Finish: blue enamel

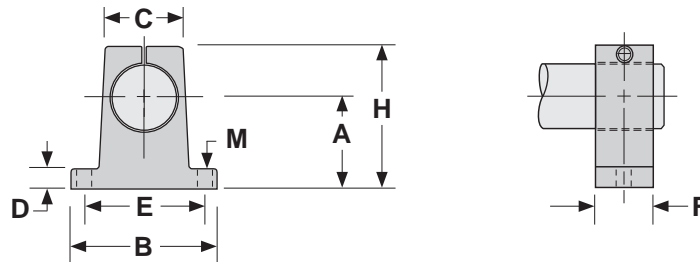

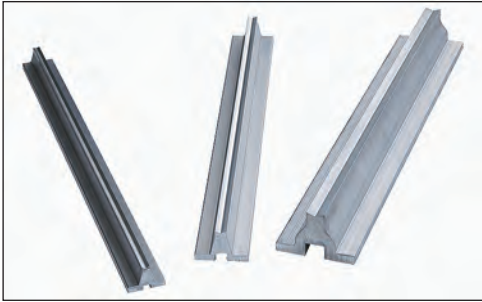

ARS 10 - PD - 24

Aluminum Rail Support

Shaft Diameter Supported

- 8** - 0.500 inch diameter
- 10** - 0.625 inch diameter
- 12** - 0.750 inch diameter
- 16** - 1.000 inch diameter
- 20** - 1.250 inch diameter
- 24** - 1.500 inch diameter
- 32** - 2.000 inch diameter

Pre-Drilled

- No mounting hole pattern
- PD** - pre-drilled hole pattern

Support length

- 24** - 24 inch length

Dimensions & Specifications: **ARS-PD** Shaft Support

Model Number Without Holes	Model Number With Pre-drilled Holes	Nominal Shaft Diameter (inches)	Dimensions (inches)										Support Weight (lbs/in)
			A +/- .002	B	C	D	E +/- .010	F hole	G bolt size	H	I		
ARS8	ARS8-PD	0.500	1.125	1.500	.250	.187	1.000	.169	#6-32 x 0.87	2.00	4.00	.050	
ARS10	ARS10-PD	0.625	1.125	1.625	.312	.250	1.125	.193	#8-32 x 0.87	2.00	4.00	.063	
ARS12	ARS12-PD	0.750	1.500	1.750	.375	.250	1.250	.221	#10-32 x 1.25	3.00	6.00	.083	
ARS16	ARS16-PD	1.000	1.750	2.125	.500	.250	1.500	.281	1/4-20 x 1.50	3.00	6.00	.108	
ARS20	ARS20-PD	1.250	2.125	2.500	.562	.312	1.875	.343	5/16-18 x 1.75	3.00	6.00	.146	
ARS24	ARS24-PD	1.500	2.500	3.000	.687	.375	2.250	.406	3/8-16 x 2.00	4.00	8.00	.213	
ARS32	ARS32-PD	2.000	3.250	3.750	.875	.500	2.750	.531	1/2-13 x 3.25	4.00	8.00	.342	

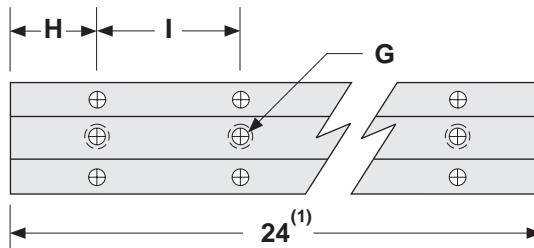
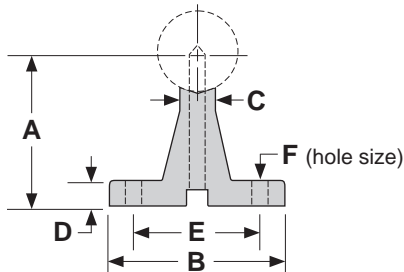

Material: 6061-T6 aluminum
Finish: natural finish

Shorter lengths available. Contact the factory.



LSRS 10 - PD - 48

Low Profile Steel Rail Support

Shaft Diameter Supported

- 8** - 0.500 inch diameter
- 10** - 0.625 inch diameter
- 12** - 0.750 inch diameter
- 16** - 1.000 inch diameter
- 20** - 1.250 inch diameter
- 24** - 1.500 inch diameter
- 32** - 2.000 inch diameter

Pre-Drilled

- No mounting hole pattern
- PD** - pre-drilled hole pattern

Support length

- 48** - 48 inch length

Dimensions & Specifications: **LSRS-PD** Shaft Support

Model Number		Nominal Shaft Diameter (inches)	Dimensions (inches)							Support Weight (lbs/in)	
Without Holes	With Pre-drilled Holes		A +/- .002	B	C	G		H	I		
						hole	bolt size				
LSRS8	LSRS8-PD	0.500	0.562	0.37	.341	.169	#6-32	2.00	4.00	.028	
LSRS10	LSRS10-PD	0.625	0.687	0.45	.412	.193	#8-32	2.00	4.00	.041	
LSRS12	LSRS12-PD	0.750	0.750	0.51	.420	.221	#10-32	3.00	6.00	.047	
LSRS16	LSRS16-PD	1.000	1.000	0.69	.560	.281	1/4-20	3.00	6.00	.089	
LSRS20	LSRS20-PD	1.250	1.187	0.78	.626	.343	5/16-18	3.00	6.00	.106	
LSRS24	LSRS24-PD	1.500	1.375	0.93	.703	.406	3/8-16	4.00	8.00	.140	
LSRS32	LSRS32-PD	2.000	1.750	1.18	.845	.531	1/2-13	4.00	8.00	.230	

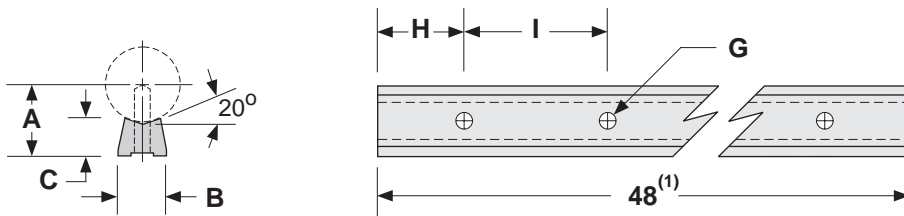

Material: AISI C-1018 steel
Finish: natural finish

Shorter lengths available. Contact the factory.

Notes



TRSA **12** - **6** - **SS** - **E4**

Assembly Type _____

SA - Single rail shaft assembly
TRSA - *TWIN RAIL*® shaft assembly

Shaft Diameter _____

8 - 0.500 inch diameter
10 - 0.625 inch diameter
12 - 0.750 inch diameter
16 - 1.000 inch diameter
20 - 1.250 inch diameter
24 - 1.500 inch diameter
32 - 2.000 inch diameter

Overall Length _____

xxx - inches

Shaft Material _____

- 1060 Steel
SS - 440C Stainless Steel
CR - Chrome Plated 1060 Steel

End Stops _____

- No end stops
E1 - One end stop
E2 - Two end stops
E3 - Three end stops
E4 - Four end stops

Specifications: SA & TRSA Shaft Assemblies

Support Type & Finish	Precision Machined 6061-T6 Aluminum, Black Anodized		
Shaft Straightness	0.001/0.002 in/ft, cumulative		
Shaft Parallelism (TRSA only)	+/- 0.002 in overall		
Shaft Type	SL - 1060 Steel or 440C Stainless steel		
Shaft Roundness	0.000080 inches		
Shaft Chamfer	For 0.50 - 0.75 inch dia. : 0.03 inch x 45°, For 1.00 - 2.00 inch dia. : 0.06 inch x 45°		
Surface Finish	8 - 12 R _a microinch		
Diameter Tolerance	Nominal Shaft Diameter	Shaft Diameter Tolerance	Minimum Hardness Depth
Hardness Depth	(inches)	(inches)	(inches)
	0.500	.4995 / .4990	0.040
	0.625	.6245 / .6240	0.040
	0.750	.7495 / .7490	0.060
	1.000	.9995 / .9990	0.080
	1.250	1.2495 / 1.2490	0.080
	1.500	1.4994 / 1.4989	0.080
	2.000	1.9994 / 1.9987	0.100

Dimensions & Specifications: SA Shaft Assembly

Model Number	Nominal Shaft Diameter (inches)	Overall Length (inches)	Dimensions (inches)							Assembly Weight (lbs)
			A +/- .002	B	C	D	E +/- .010	F hole	G bolt size	
SA8-6	0.500	6	1.125	1.500	.250	.187	1.000	.169	#6-32	0.5
SA10-6	0.625	6	1.125	1.625	.312	.250	1.125	.193	#8-32	0.8
SA12-6	0.750	6	1.500	1.750	.375	.250	1.250	.221	#10-32	1.0
SA16-6	1.000	6	1.750	2.125	.500	.250	1.500	.281	1/4-20	1.7
SA20-6 ⁽¹⁾	1.250	6	2.125	2.500	.562	.312	1.875	.281	1/4-20	2.7
SA24-6 ⁽¹⁾	1.500	6	2.500	3.000	.687	.375	2.250	.343	5/16-18	3.7
SA32-6 ⁽¹⁾	2.000	6	3.250	3.750	.875	.500	2.750	.406	3/8-16	6.4
SA8-12	0.500	12	1.125	1.500	.250	.187	1.000	.169	#6-32	0.9
SA10-12	0.625	12	1.125	1.625	.312	.250	1.125	.193	#8-32	1.5
SA12-12	0.750	12	1.500	1.750	.375	.250	1.250	.221	#10-32	2.0
SA16-12	1.000	12	1.750	2.125	.500	.250	1.500	.281	1/4-20	3.4
SA20-12	1.250	12	2.125	2.500	.562	.312	1.875	.281	1/4-20	5.3
SA24-12	1.500	12	2.500	3.000	.687	.375	2.250	.343	5/16-18	7.3
SA32-12 ⁽¹⁾	2.000	12	3.250	3.750	.875	.500	2.750	.406	3/8-16	12.8
SA8-18	0.500	18	1.125	1.500	.250	.187	1.000	.169	#6-32	1.4
SA10-18	0.625	18	1.125	1.625	.312	.250	1.125	.193	#8-32	2.2
SA12-18	0.750	18	1.500	1.750	.375	.250	1.250	.221	#10-32	3.0
SA16-18	1.000	18	1.750	2.125	.500	.250	1.500	.281	1/4-20	5.1
SA20-18	1.250	18	2.125	2.500	.562	.312	1.875	.281	1/4-20	7.9
SA24-18	1.500	18	2.500	3.000	.687	.375	2.250	.343	5/16-18	11.0
SA32-18 ⁽¹⁾	2.000	18	3.250	3.750	.875	.500	2.750	.406	3/8-16	19.2
SA8-24	0.500	24	1.125	1.500	.250	.187	1.000	.169	#6-32	1.8
SA10-24	0.625	24	1.125	1.625	.312	.250	1.125	.193	#8-32	2.9
SA12-24	0.750	24	1.500	1.750	.375	.250	1.250	.221	#10-32	4.0
SA16-24	1.000	24	1.750	2.125	.500	.250	1.500	.281	1/4-20	6.8
SA20-24	1.250	24	2.125	2.500	.562	.312	1.875	.281	1/4-20	10.5
SA24-24	1.500	24	2.500	3.000	.687	.375	2.250	.343	5/16-18	14.6
SA32-24	2.000	24	3.250	3.750	.875	.500	2.750	.406	3/8-16	25.6
SA8-30	0.500	30	1.125	1.500	.250	.187	1.000	.169	#6-32	2.3
SA10-30	0.625	30	1.125	1.625	.312	.250	1.125	.193	#8-32	3.6
SA12-30	0.750	30	1.500	1.750	.375	.250	1.250	.221	#10-32	5.0
SA16-30	1.000	30	1.750	2.125	.500	.250	1.500	.281	1/4-20	8.4
SA20-30	1.250	30	2.125	2.500	.562	.312	1.875	.281	1/4-20	13.1
SA24-30	1.500	30	2.500	3.000	.687	.375	2.250	.343	5/16-18	18.3
SA32-30	2.000	30	3.250	3.750	.875	.500	2.750	.406	3/8-16	32.0

Footnotes:

(1) Not a stock item, but available upon request.

Dimensions

(inches)

Sold & Serviced By:

Toll Free Phone (877) SERV098
 Toll Free Fax (877) SERV099
www.electromate.com
sales@electromate.com

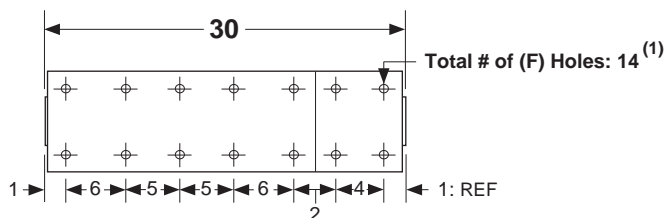
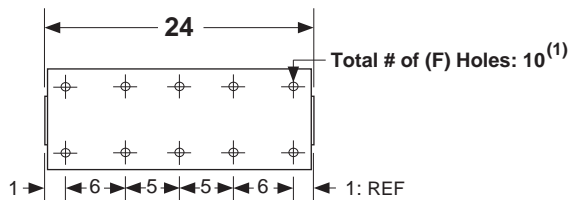
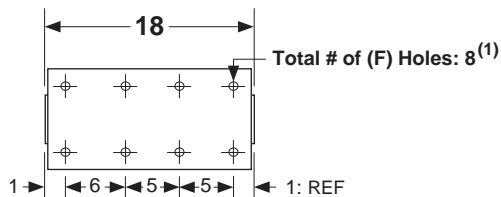
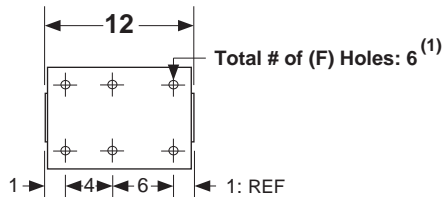
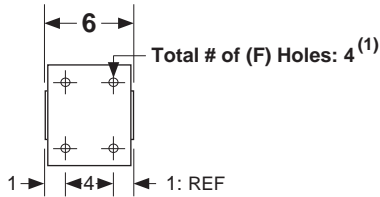
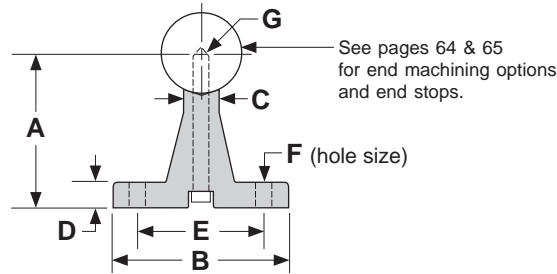

Footnotes:

(1) Shaft supports come in 6, 12, 18 and 24 inch segments. The mounting hole location linear tolerance is +/- .010 inches noncumulative per segment. These supports are not one piece for lengths over 24 inches. The mounting hole linear tolerance is +/- .015 inches cumulative from one support segment to the next.

Dimensions & Specifications: SA Shaft Assembly

Model Number	Nominal Shaft Diameter (inches)	Overall Length (inches)	Dimensions (inches)							Assembly Weight (lbs)
			A +/- .002	B	C	D	E +/- .010	F hole	G bolt size	
SA8-36	0.500	36	1.125	1.500	.250	.187	1.000	.169	#6-32	2.7
SA10-36	0.625	36	1.125	1.625	.312	.250	1.125	.193	#8-32	4.3
SA12-36	0.750	36	1.500	1.750	.375	.250	1.250	.221	#10-32	6.0
SA16-36	1.000	36	1.750	2.125	.500	.250	1.500	.281	1/4-20	10.1
SA20-36	1.250	36	2.125	2.500	.562	.312	1.875	.281	1/4-20	15.7
SA24-36	1.500	36	2.500	3.000	.687	.375	2.250	.343	5/16-18	21.9
SA32-36	2.000	36	3.250	3.750	.875	.500	2.750	.406	3/8-16	38.4
SA8-42	0.500	42	1.125	1.500	.250	.187	1.000	.169	#6-32	3.2
SA10-42	0.625	42	1.125	1.625	.312	.250	1.125	.193	#8-32	5.1
SA12-42	0.750	42	1.500	1.750	.375	.250	1.250	.221	#10-32	7.0
SA16-42	1.000	42	1.750	2.125	.500	.250	1.500	.281	1/4-20	11.8
SA20-42	1.250	42	2.125	2.500	.562	.312	1.875	.281	1/4-20	18.4
SA24-42	1.500	42	2.500	3.000	.687	.375	2.250	.343	5/16-18	25.6
SA32-42	2.000	42	3.250	3.750	.875	.500	2.750	.406	3/8-16	44.8
SA8-48	0.500	48	1.125	1.500	.250	.187	1.000	.169	#6-32	3.6
SA10-48	0.625	48	1.125	1.625	.312	.250	1.125	.193	#8-32	5.8
SA12-48	0.750	48	1.500	1.750	.375	.250	1.250	.221	#10-32	8.0
SA16-48	1.000	48	1.750	2.125	.500	.250	1.500	.281	1/4-20	13.5
SA20-48	1.250	48	2.125	2.500	.562	.312	1.875	.281	1/4-20	21.0
SA24-48	1.500	48	2.500	3.000	.687	.375	2.250	.343	5/16-18	29.2
SA32-48	2.000	48	3.250	3.750	.875	.500	2.750	.406	3/8-16	51.2
SA8-54	0.500	54	1.125	1.500	.250	.187	1.000	.169	#6-32	4.1
SA10-54	0.625	54	1.125	1.625	.312	.250	1.125	.193	#8-32	6.5
SA12-54	0.750	54	1.500	1.750	.375	.250	1.250	.221	#10-32	9.0
SA16-54	1.000	54	1.750	2.125	.500	.250	1.500	.281	1/4-20	15.2
SA20-54	1.250	54	2.125	2.500	.562	.312	1.875	.281	1/4-20	23.6
SA24-54	1.500	54	2.500	3.000	.687	.375	2.250	.343	5/16-18	32.9
SA32-54	2.000	54	3.250	3.750	.875	.500	2.750	.406	3/8-16	57.6
SA8-60	0.500	60	1.125	1.500	.250	.187	1.000	.169	#6-32	4.5
SA10-60	0.625	60	1.125	1.625	.312	.250	1.125	.193	#8-32	7.2
SA12-60	0.750	60	1.500	1.750	.375	.250	1.250	.221	#10-32	10.0
SA16-60	1.000	60	1.750	2.125	.500	.250	1.500	.281	1/4-20	16.8
SA20-60	1.250	60	2.125	2.500	.562	.312	1.875	.281	1/4-20	26.2
SA24-60	1.500	60	2.500	3.000	.687	.375	2.250	.343	5/16-18	36.5
SA32-60	2.000	60	3.250	3.750	.875	.500	2.750	.406	3/8-16	63.9

Sold & Serviced By:



Toll Free Phone (877) SERV098

Toll Free Fax (877) SERV099

www.electromate.com

sales@electromate.com

Specifications subject to change without notice

Dimensions

(inches)

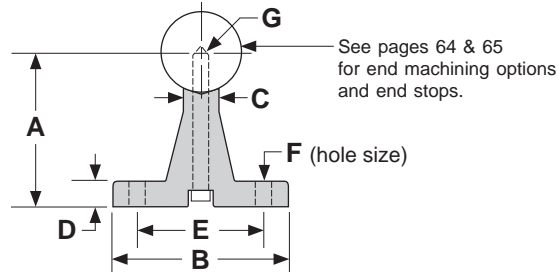

Sold & Serviced By:

 Toll Free Phone (877) SERV098
 Toll Free Fax (877) SERV099
www.electromate.com
sales@electromate.com

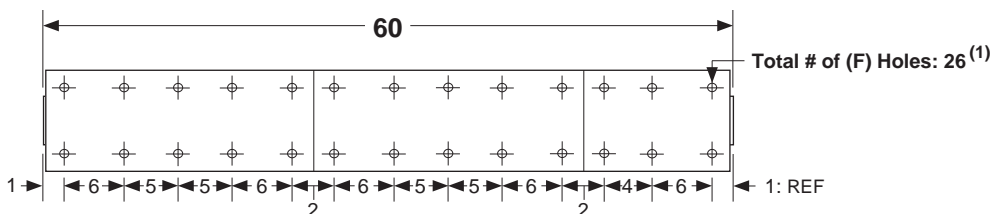
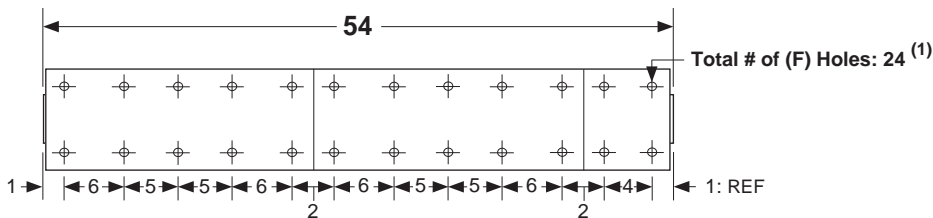
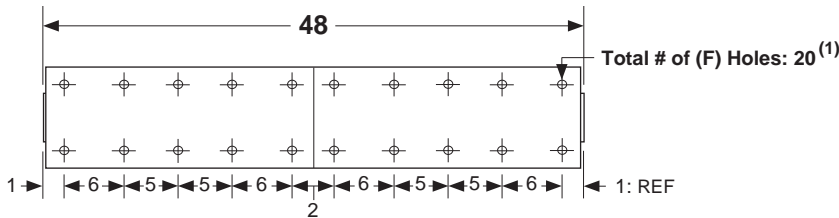
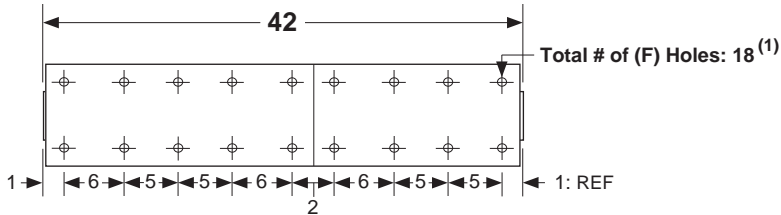
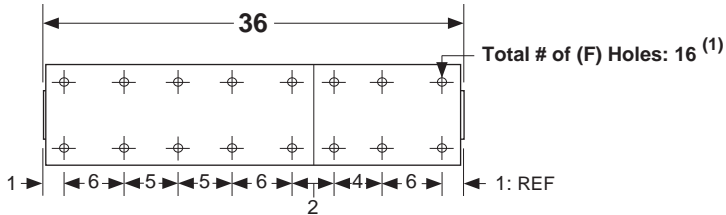

Footnotes:

(1) Shaft supports come in 6, 12, 18 and 24 inch segments. The mounting hole location linear tolerance is +/- .010 inches noncumulative per segment. These supports are not one piece for lengths over 24 inches. The mounting hole linear tolerance is +/- .015 inches cumulative from one support segment to the next.

Dimensions & Specifications: SA Shaft Assembly

Model Number	Nominal Shaft Diameter (inches)	Overall Length (inches)	Dimensions (inches)							Assembly Weight (lbs)
			A +/- .002	B	C	D	E +/- .010	F hole	G bolt size	
SA8-66	0.500	66	1.125	1.500	.250	.187	1.000	.169	#6-32	5.0
SA10-66	0.625	66	1.125	1.625	.312	.250	1.125	.193	#8-32	7.9
SA12-66	0.750	66	1.500	1.750	.375	.250	1.250	.221	#10-32	11.0
SA16-66	1.000	66	1.750	2.125	.500	.250	1.500	.281	1/4-20	18.5
SA20-66	1.250	66	2.125	2.500	.562	.312	1.875	.281	1/4-20	28.8
SA24-66	1.500	66	2.500	3.000	.687	.375	2.250	.343	5/16-18	40.2
SA32-66	2.000	66	3.250	3.750	.875	.500	2.750	.406	3/8-16	70.3
SA8-72	0.500	72	1.125	1.500	.250	.187	1.000	.169	#6-32	5.4
SA10-72	0.625	72	1.125	1.625	.312	.250	1.125	.193	#8-32	8.6
SA12-72	0.750	72	1.500	1.750	.375	.250	1.250	.221	#10-32	12.0
SA16-72	1.000	72	1.750	2.125	.500	.250	1.500	.281	1/4-20	20.2
SA20-72	1.250	72	2.125	2.500	.562	.312	1.875	.281	1/4-20	31.4
SA24-72	1.500	72	2.500	3.000	.687	.375	2.250	.343	5/16-18	43.8
SA32-72	2.000	72	3.250	3.750	.875	.500	2.750	.406	3/8-16	76.7
SA8-84	0.500	84	1.125	1.500	.250	.187	1.000	.169	#6-32	6.3
SA10-84	0.625	84	1.125	1.625	.312	.250	1.125	.193	#8-32	10.0
SA12-84	0.750	84	1.500	1.750	.375	.250	1.250	.221	#10-32	14.0
SA16-84	1.000	84	1.750	2.125	.500	.250	1.500	.281	1/4-20	23.6
SA20-84	1.250	84	2.125	2.500	.562	.312	1.875	.281	1/4-20	36.6
SA24-84	1.500	84	2.500	3.000	.687	.375	2.250	.343	5/16-18	51.1
SA32-84	2.000	84	3.250	3.750	.875	.500	2.750	.406	3/8-16	89.5
SA8-96	0.500	96	1.125	1.500	.250	.187	1.000	.169	#6-32	7.2
SA10-96	0.625	96	1.125	1.625	.312	.250	1.125	.193	#8-32	11.5
SA12-96	0.750	96	1.500	1.750	.375	.250	1.250	.221	#10-32	16.0
SA16-96	1.000	96	1.750	2.125	.500	.250	1.500	.281	1/4-20	26.9
SA20-96	1.250	96	2.125	2.500	.562	.312	1.875	.281	1/4-20	41.9
SA24-96	1.500	96	2.500	3.000	.687	.375	2.250	.343	5/16-18	58.4
SA32-96	2.000	96	3.250	3.750	.875	.500	2.750	.406	3/8-16	102.3
SA8-108	0.500	108	1.125	1.500	.250	.187	1.000	.169	#6-32	8.1
SA10-108	0.625	108	1.125	1.625	.312	.250	1.125	.193	#8-32	12.9
SA12-108	0.750	108	1.500	1.750	.375	.250	1.250	.221	#10-32	18.0
SA16-108	1.000	108	1.750	2.125	.500	.250	1.500	.281	1/4-20	30.3
SA20-108	1.250	108	2.125	2.500	.562	.312	1.875	.281	1/4-20	47.1
SA24-108	1.500	108	2.500	3.000	.687	.375	2.250	.343	5/16-18	65.7
SA32-108	2.000	108	3.250	3.750	.875	.500	2.750	.406	3/8-16	115.1

Sold & Serviced By:



Toll Free Phone (877) SERV098

Toll Free Fax (877) SERV099

www.electromate.com

sales@electromate.com

Specifications subject to change without notice

Dimensions

(inches)

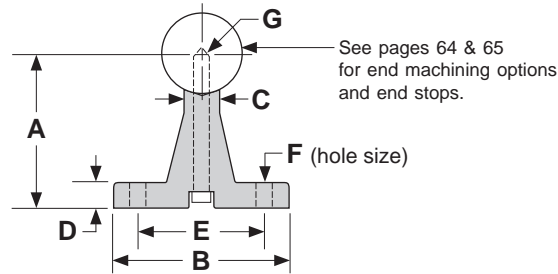

Sold & Serviced By:

 Toll Free Phone (877) SERV098
 Toll Free Fax (877) SERV099
www.electromate.com
sales@electromate.com

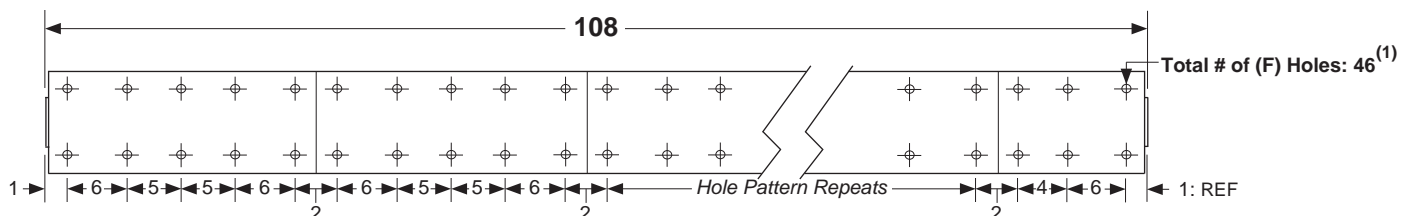
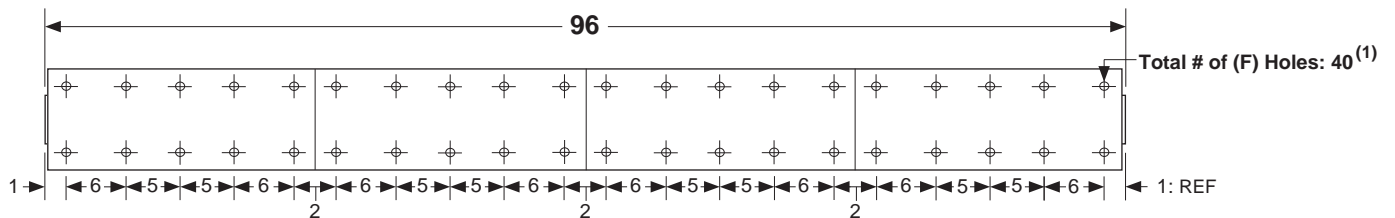
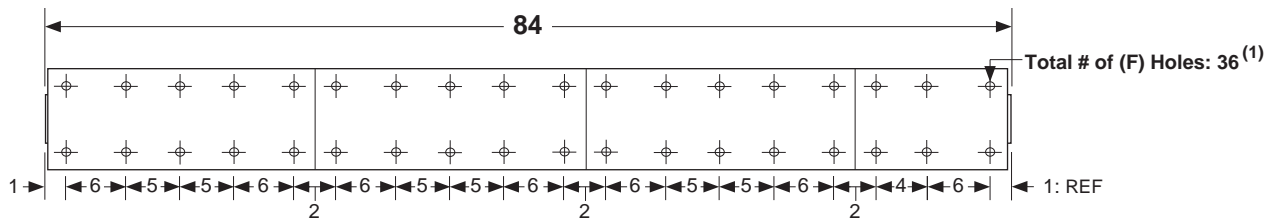
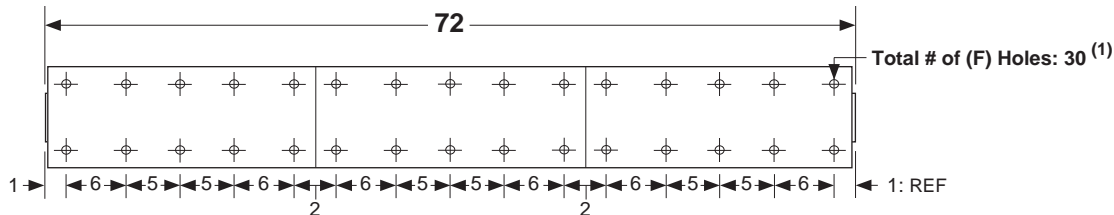
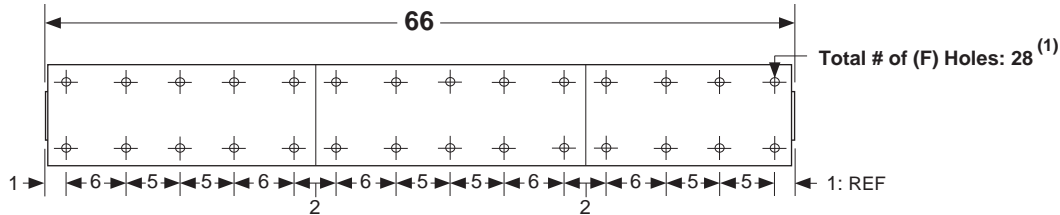

Footnotes:

(1) Shaft supports come in 6, 12, 18 and 24 inch segments. The mounting hole location linear tolerance is +/- .010 inches noncumulative per segment. These supports are not one piece for lengths over 24 inches. The mounting hole linear tolerance is +/- .015 inches cumulative from one support segment to the next.

Dimensions & Specifications: SA Shaft Assembly

Model Number	Nominal Shaft Diameter (inches)	Overall Length (inches)	Dimensions (inches)							Assembly Weight (lbs)
			A +/- .002	B	C	D	E +/- .010	F hole	G bolt size	
SA8-120	0.500	120	1.125	1.500	.250	.187	1.000	.169	#6-32	9.0
SA10-120	0.625	120	1.125	1.625	.312	.250	1.125	.193	#8-32	14.3
SA12-120	0.750	120	1.500	1.750	.375	.250	1.250	.221	#10-32	20.0
SA16-120	1.000	120	1.750	2.125	.500	.250	1.500	.281	1/4-20	33.6
SA20-120	1.250	120	2.125	2.500	.562	.312	1.875	.281	1/4-20	52.3
SA24-120	1.500	120	2.500	3.000	.687	.375	2.250	.343	5/16-18	73.0
SA32-120	2.000	120	3.250	3.750	.875	.500	2.750	.406	3/8-16	127.8
SA8-144	0.500	144	1.125	1.500	.250	.187	1.000	.169	#6-32	10.8
SA10-144	0.625	144	1.125	1.625	.312	.250	1.125	.193	#8-32	17.2
SA12-144	0.750	144	1.500	1.750	.375	.250	1.250	.221	#10-32	24.0
SA16-144	1.000	144	1.750	2.125	.500	.250	1.500	.281	1/4-20	40.4
SA20-144	1.250	144	2.125	2.500	.562	.312	1.875	.281	1/4-20	62.8
SA24-144	1.500	144	2.500	3.000	.687	.375	2.250	.343	5/16-18	87.6
SA32-144	2.000	144	3.250	3.750	.875	.500	2.750	.406	3/8-16	153.4
SA12-168	0.750	168	1.500	1.750	.375	.250	1.250	.221	#10-32	28.0
SA16-168	1.000	168	1.750	2.125	.500	.250	1.500	.281	1/4-20	47.1
SA20-168	1.250	168	2.125	2.500	.562	.312	1.875	.281	1/4-20	73.3
SA24-168	1.500	168	2.500	3.000	.687	.375	2.250	.343	5/16-18	102.2
SA32-168	2.000	168	3.250	3.750	.875	.500	2.750	.406	3/8-16	179.0
SA12-192	0.750	192	1.500	1.750	.375	.250	1.250	.221	#10-32	32.0
SA16-192	1.000	192	1.750	2.125	.500	.250	1.500	.281	1/4-20	53.8
SA20-192	1.250	192	2.125	2.500	.562	.312	1.875	.281	1/4-20	83.7
SA24-192	1.500	192	2.500	3.000	.687	.375	2.250	.343	5/16-18	116.8
SA32-192	2.000	192	3.250	3.750	.875	.500	2.750	.406	3/8-16	204.5

Sold & Serviced By:

 **ELECTROMATE**

Toll Free Phone (877) SERV098

Toll Free Fax (877) SERV099

www.electromate.com

sales@electromate.com

Specifications subject to change without notice

Dimensions

(inches)

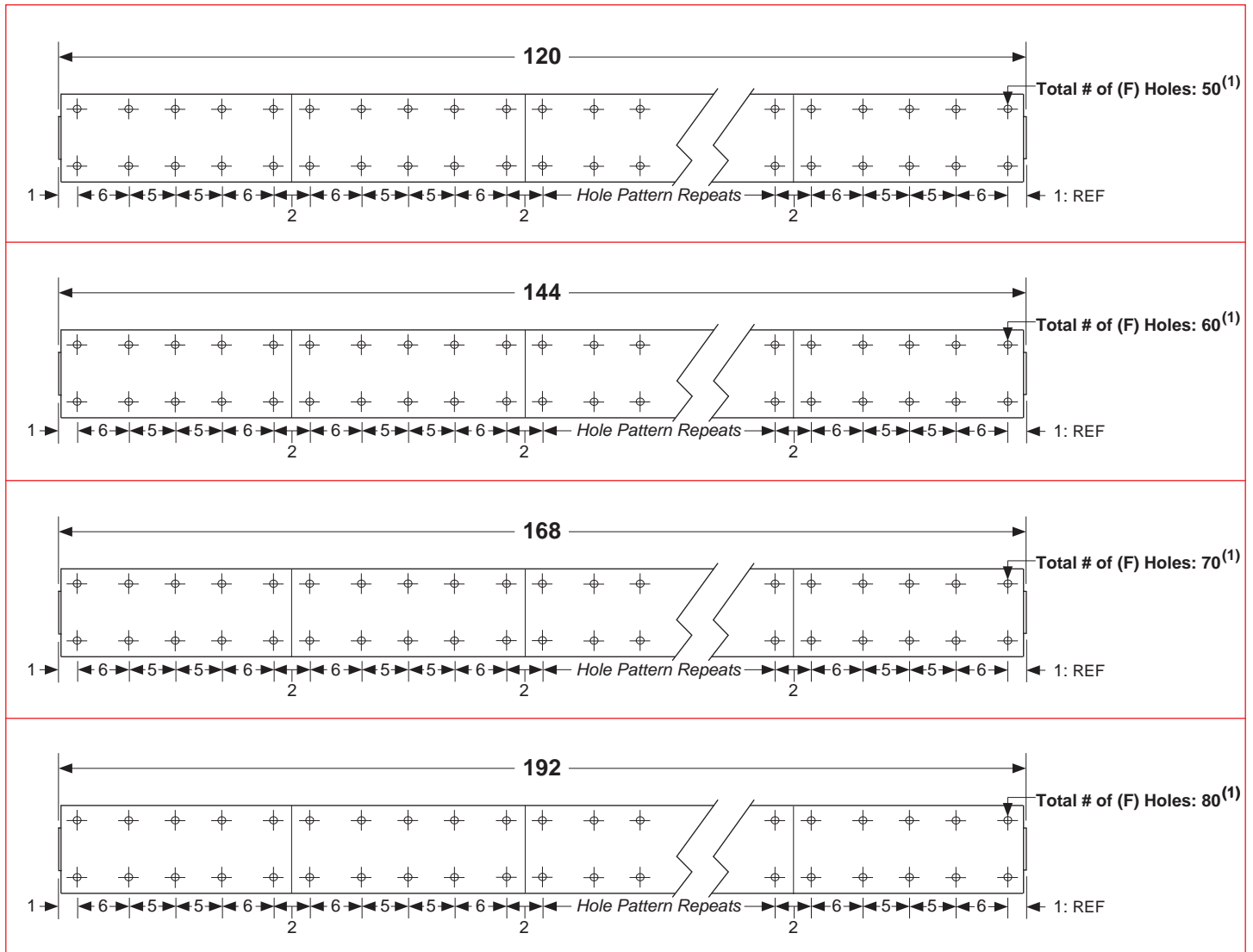
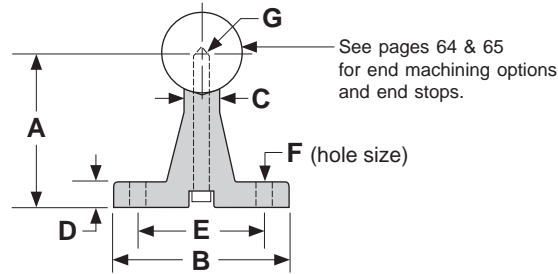

Footnotes:

(1) Shaft supports come in 6, 12, 18 and 24 inch segments. The mounting hole location linear tolerance is +/- .010 inches noncumulative per segment. These supports are not one piece for lengths over 24 inches. The mounting hole linear tolerance is +/- .015 inches cumulative from one support segment to the next.

Dimensions & Specifications: TRSA TWIN RAIL® Shaft Assembly

Sold & Serviced By:

 Toll Free Phone (877) SERV098
 Toll Free Fax (877) SERV099
www.electromate.com
sales@electromate.com

Model Number	Nominal Shaft Diameter (inches)	Overall Length (inches)	Dimensions (inches)											Assembly Weight (lbs)
			A +/- .002	B +/- .002	C	D	E +/- .010	F	G	H	J hole	K Bolt Size	L ⁽²⁾ Thread	
TRSA8-6	0.500	6	1.125	3.000	3.750	0.875	2.000	.375	.312	.250	.169	#6-32	#10-32	1.8
TRSA10-6	0.625	6	1.125	3.750	4.625	1.000	2.625	.437	.312	.312	.193	#8-32	#10-32	2.4
TRSA12-6	0.750	6	1.500	4.500	5.500	1.125	3.250	.500	.312	.375	.221	#10-32	#10-32	3.4
TRSA16-6	1.000	6	1.750	5.250	6.375	1.312	3.750	.562	.312	.500	.281	1/4-20	#10-32	5.0
TRSA20-6 ⁽¹⁾	1.250	6	2.125	6.000	7.250	1.562	4.125	.625	.375	.562	.281	1/4-20	1/4-20	7.5
TRSA24-6 ⁽¹⁾	1.500	6	2.500	6.625	8.125	1.875	4.375	.750	.437	.687	.343	5/16-18	5/16-18	10.5
TRSA32-6 ⁽¹⁾	2.000	6	3.250	7.250	9.000	2.250	4.500	.875	.562	.875	.406	3/8-16	3/8-16	15.7
TRSA8-12	0.500	12	1.125	3.000	3.750	0.875	2.000	.375	.312	.250	.169	#6-32	#10-32	3.6
TRSA10-12	0.625	12	1.125	3.750	4.625	1.000	2.625	.437	.312	.312	.193	#8-32	#10-32	4.8
TRSA12-12	0.750	12	1.500	4.500	5.500	1.125	3.250	.500	.312	.375	.221	#10-32	#10-32	6.8
TRSA16-12	1.000	12	1.750	5.250	6.375	1.312	3.750	.562	.312	.500	.281	1/4-20	#10-32	10.0
TRSA20-12	1.250	12	2.125	6.000	7.250	1.562	4.125	.625	.375	.562	.281	1/4-20	1/4-20	15.0
TRSA24-12	1.500	12	2.500	6.625	8.125	1.875	4.375	.750	.437	.687	.343	5/16-18	5/16-18	21.0
TRSA32-12 ⁽¹⁾	2.000	12	3.250	7.250	9.000	2.250	4.500	.875	.562	.875	.406	3/8-16	3/8-16	31.3
TRSA8-18	0.500	18	1.125	3.000	3.750	0.875	2.000	.375	.312	.250	.169	#6-32	#10-32	5.4
TRSA10-18	0.625	18	1.125	3.750	4.625	1.000	2.625	.437	.312	.312	.193	#8-32	#10-32	7.2
TRSA12-18	0.750	18	1.500	4.500	5.500	1.125	3.250	.500	.312	.375	.221	#10-32	#10-32	10.1
TRSA16-18	1.000	18	1.750	5.250	6.375	1.312	3.750	.562	.312	.500	.281	1/4-20	#10-32	15.0
TRSA20-18	1.250	18	2.125	6.000	7.250	1.562	4.125	.625	.375	.562	.281	1/4-20	1/4-20	22.4
TRSA24-18	1.500	18	2.500	6.625	8.125	1.875	4.375	.750	.437	.687	.343	5/16-18	5/16-18	31.4
TRSA32-18 ⁽¹⁾	2.000	18	3.250	7.250	9.000	2.250	4.500	.875	.562	.875	.406	3/8-16	3/8-16	46.9
TRSA8-24	0.500	24	1.125	3.000	3.750	0.875	2.000	.375	.312	.250	.169	#6-32	#10-32	7.2
TRSA10-24	0.625	24	1.125	3.750	4.625	1.000	2.625	.437	.312	.312	.193	#8-32	#10-32	9.6
TRSA12-24	0.750	24	1.500	4.500	5.500	1.125	3.250	.500	.312	.375	.221	#10-32	#10-32	13.5
TRSA16-24	1.000	24	1.750	5.250	6.375	1.312	3.750	.562	.312	.500	.281	1/4-20	#10-32	20.0
TRSA20-24	1.250	24	2.125	6.000	7.250	1.562	4.125	.625	.375	.562	.281	1/4-20	1/4-20	29.9
TRSA24-24	1.500	24	2.500	6.625	8.125	1.875	4.375	.750	.437	.687	.343	5/16-18	5/16-18	41.9
TRSA32-24	2.000	24	3.250	7.250	9.000	2.250	4.500	.875	.562	.875	.406	3/8-16	3/8-16	62.5
TRSA8-30	0.500	30	1.125	3.000	3.750	0.875	2.000	.375	.312	.250	.169	#6-32	#10-32	9.0
TRSA10-30	0.625	30	1.125	3.750	4.625	1.000	2.625	.437	.312	.312	.193	#8-32	#10-32	12.0
TRSA12-30	0.750	30	1.500	4.500	5.500	1.125	3.250	.500	.312	.375	.221	#10-32	#10-32	16.8
TRSA16-30	1.000	30	1.750	5.250	6.375	1.312	3.750	.562	.312	.500	.281	1/4-20	#10-32	25.0
TRSA20-30	1.250	30	2.125	6.000	7.250	1.562	4.125	.625	.375	.562	.281	1/4-20	1/4-20	37.3
TRSA24-30	1.500	30	2.500	6.625	8.125	1.875	4.375	.750	.437	.687	.343	5/16-18	5/16-18	52.3
TRSA32-30	2.000	30	3.250	7.250	9.000	2.250	4.500	.875	.562	.875	.406	3/8-16	3/8-16	78.1

Footnotes:

(1) Not a stock item, but available upon request.

(2) Two threaded leveling holes per TWIN RAIL® support segment are used for setscrew adjustment to aid in assembly leveling to the user mounting surfaces.

Dimensions

(inches)

Sold & Serviced By:

Toll Free Phone (877) SERV098
 Toll Free Fax (877) SERV099
www.electromate.com
sales@electromate.com

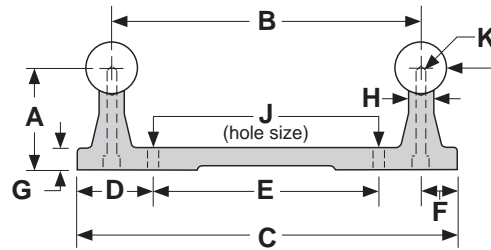

See pages 64 & 65
 for end machining options
 and end stops.

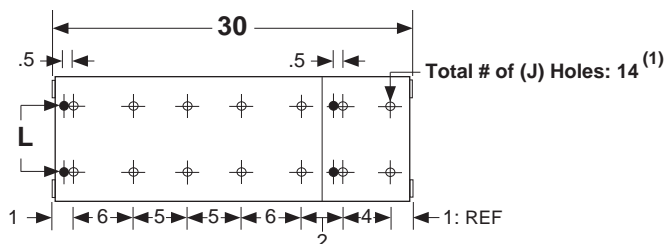
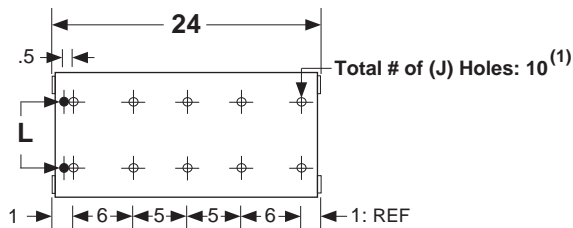
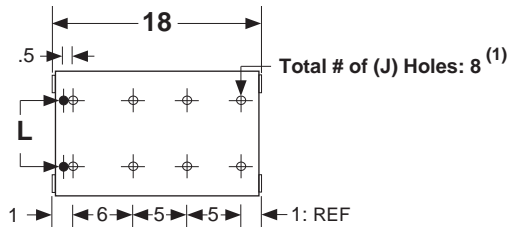
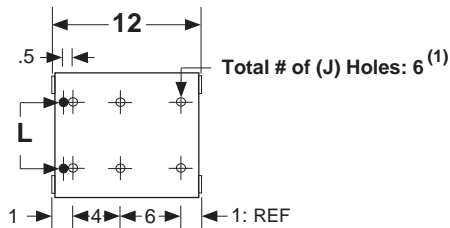
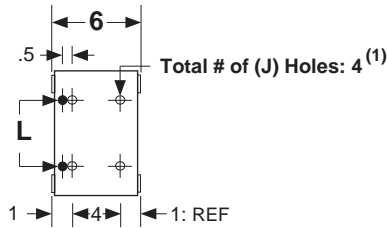

Footnotes:

(1) *TWIN RAIL*® supports come in 6, 12, 18 and 24 inch segments. The mounting hole location linear tolerance is +/- .010 inches noncumulative per segment. The supports are not one piece for lengths over 24 inches. The mounting hole linear tolerance is +/- .015 inches cumulative from one support segment to the next.

Dimensions & Specifications: TRSA TWIN RAIL® Shaft Assembly

Sold & Serviced By:

 Toll Free Phone (877) SERV098
 Toll Free Fax (877) SERV099
www.electromate.com
sales@electromate.com

Model Number	Nominal Shaft Diameter (inches)	Overall Length (inches)	Dimensions (inches)											Assembly Weight (lbs)
			A +/- .002	B +/- .002	C	D	E +/- .010	F	G	H	J hole	K Bolt Size	L ⁽¹⁾ Thread	
TRSA8-36	0.500	36	1.125	3.000	3.750	0.875	2.000	.375	.312	.250	.169	#6-32	#10-32	10.8
TRSA10-36	0.625	36	1.125	3.750	4.625	1.000	2.625	.437	.312	.312	.193	#8-32	#10-32	14.4
TRSA12-36	0.750	36	1.500	4.500	5.500	1.125	3.250	.500	.312	.375	.221	#10-32	#10-32	20.2
TRSA16-36	1.000	36	1.750	5.250	6.375	1.312	3.750	.562	.312	.500	.281	1/4-20	#10-32	30.0
TRSA20-36	1.250	36	2.125	6.000	7.250	1.562	4.125	.625	.375	.562	.281	1/4-20	1/4-20	44.8
TRSA24-36	1.500	36	2.500	6.625	8.125	1.875	4.375	.750	.437	.687	.343	5/16-18	5/16-18	62.8
TRSA32-36	2.000	36	3.250	7.250	9.000	2.250	4.500	.875	.562	.875	.406	3/8-16	3/8-16	93.7
TRSA8-42	0.500	42	1.125	3.000	3.750	0.875	2.000	.375	.312	.250	.169	#6-32	#10-32	12.6
TRSA10-42	0.625	42	1.125	3.750	4.625	1.000	2.625	.437	.312	.312	.193	#8-32	#10-32	16.7
TRSA12-42	0.750	42	1.500	4.500	5.500	1.125	3.250	.500	.312	.375	.221	#10-32	#10-32	23.6
TRSA16-42	1.000	42	1.750	5.250	6.375	1.312	3.750	.562	.312	.500	.281	1/4-20	#10-32	35.0
TRSA20-42	1.250	42	2.125	6.000	7.250	1.562	4.125	.625	.375	.562	.281	1/4-20	1/4-20	52.3
TRSA24-42	1.500	42	2.500	6.625	8.125	1.875	4.375	.750	.437	.687	.343	5/16-18	5/16-18	73.2
TRSA32-42	2.000	42	3.250	7.250	9.000	2.250	4.500	.875	.562	.875	.406	3/8-16	3/8-16	109.3
TRSA8-48	0.500	48	1.125	3.000	3.750	0.875	2.000	.375	.312	.250	.169	#6-32	#10-32	14.4
TRSA10-48	0.625	48	1.125	3.750	4.625	1.000	2.625	.437	.312	.312	.193	#8-32	#10-32	19.1
TRSA12-48	0.750	48	1.500	4.500	5.500	1.125	3.250	.500	.312	.375	.221	#10-32	#10-32	26.9
TRSA16-48	1.000	48	1.750	5.250	6.375	1.312	3.750	.562	.312	.500	.281	1/4-20	#10-32	40.0
TRSA20-48	1.250	48	2.125	6.000	7.250	1.562	4.125	.625	.375	.562	.281	1/4-20	1/4-20	59.7
TRSA24-48	1.500	48	2.500	6.625	8.125	1.875	4.375	.750	.437	.687	.343	5/16-18	5/16-18	83.7
TRSA32-48	2.000	48	3.250	7.250	9.000	2.250	4.500	.875	.562	.875	.406	3/8-16	3/8-16	124.9
TRSA8-54	0.500	54	1.125	3.000	3.750	0.875	2.000	.375	.312	.250	.169	#6-32	#10-32	16.2
TRSA10-54	0.625	54	1.125	3.750	4.625	1.000	2.625	.437	.312	.312	.193	#8-32	#10-32	21.5
TRSA12-54	0.750	54	1.500	4.500	5.500	1.125	3.250	.500	.312	.375	.221	#10-32	#10-32	30.3
TRSA16-54	1.000	54	1.750	5.250	6.375	1.312	3.750	.562	.312	.500	.281	1/4-20	#10-32	45.0
TRSA20-54	1.250	54	2.125	6.000	7.250	1.562	4.125	.625	.375	.562	.281	1/4-20	1/4-20	67.2
TRSA24-54	1.500	54	2.500	6.625	8.125	1.875	4.375	.750	.437	.687	.343	5/16-18	5/16-18	94.1
TRSA32-54	2.000	54	3.250	7.250	9.000	2.250	4.500	.875	.562	.875	.406	3/8-16	3/8-16	140.5
TRSA8-60	0.500	60	1.125	3.000	3.750	0.875	2.000	.375	.312	.250	.169	#6-32	#10-32	18.0
TRSA10-60	0.625	60	1.125	3.750	4.625	1.000	2.625	.437	.312	.312	.193	#8-32	#10-32	23.9
TRSA12-60	0.750	60	1.500	4.500	5.500	1.125	3.250	.500	.312	.375	.221	#10-32	#10-32	33.6
TRSA16-60	1.000	60	1.750	5.250	6.375	1.312	3.750	.562	.312	.500	.281	1/4-20	#10-32	49.9
TRSA20-60	1.250	60	2.125	6.000	7.250	1.562	4.125	.625	.375	.562	.281	1/4-20	1/4-20	74.6
TRSA24-60	1.500	60	2.500	6.625	8.125	1.875	4.375	.750	.437	.687	.343	5/16-18	5/16-18	104.6
TRSA32-60	2.000	60	3.250	7.250	9.000	2.250	4.500	.875	.562	.875	.406	3/8-16	3/8-16	156.1

Footnotes:

(1) Two threaded leveling holes per TWIN RAIL® support segment are used for setscrew adjustment to aid in assembly leveling to the user mounting surfaces.

Dimensions

(inches)

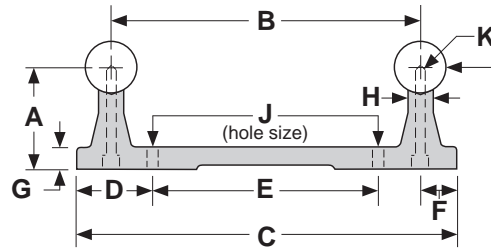

See pages 64 & 65 for end machining options and end stops.

Sold & Serviced By:

Toll Free Phone (877) SERV098
 Toll Free Fax (877) SERV099
www.electromate.com
sales@electromate.com

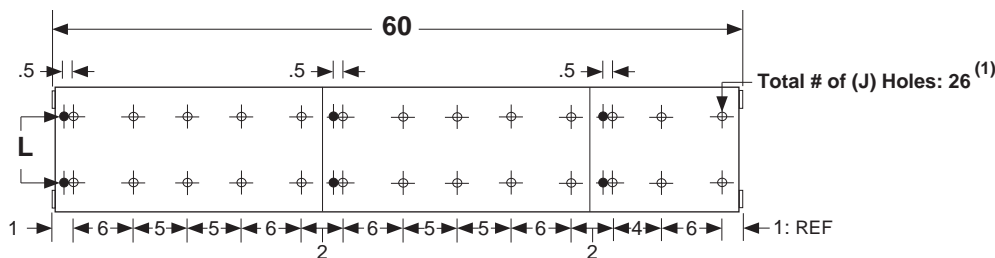
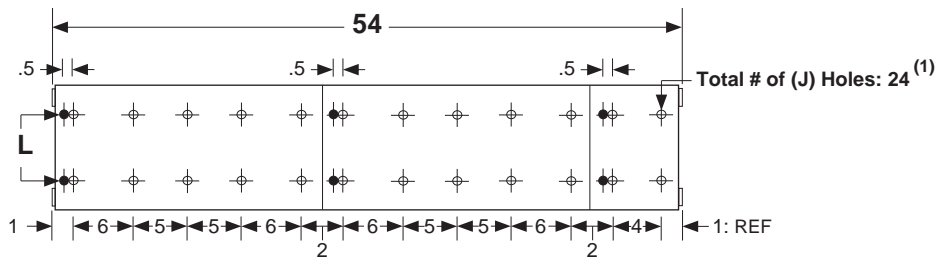
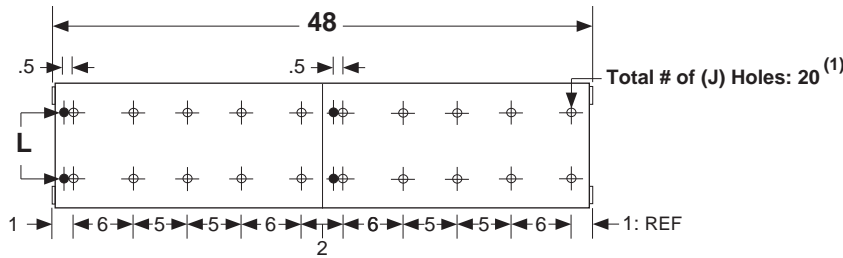
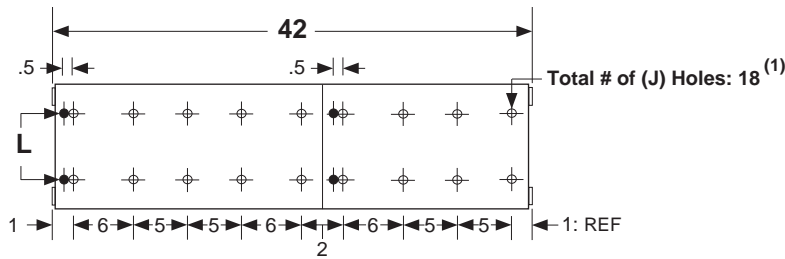
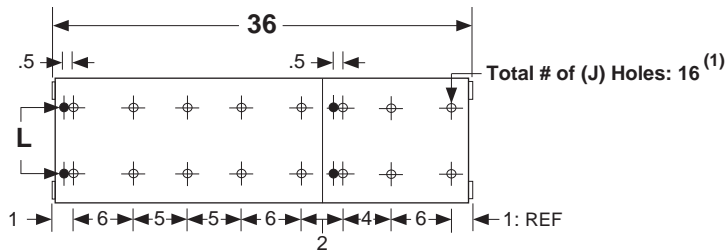

Footnotes:

(1) *TWIN RAIL*® supports come in 6, 12, 18 and 24 inch segments. The mounting hole location linear tolerance is +/- .010 inches noncumulative per segment. The supports are not one piece for lengths over 24 inches. The mounting hole linear tolerance is +/- .015 inches cumulative from one support segment to the next.

Dimensions & Specifications: TRSA TWIN RAIL® Shaft Assembly

Sold & Serviced By:

 Toll Free Phone (877) SERV098
 Toll Free Fax (877) SERV099
www.electromate.com
sales@electromate.com

Model Number	Nominal Shaft Diameter (inches)	Overall Length (inches)	Dimensions (inches)											Assembly Weight (lbs)
			A +/- .002	B +/- .002	C	D	E +/- .010	F	G	H	J hole	K Bolt Size	L ⁽¹⁾ Thread	
TRSA8-66	0.500	66	1.125	3.000	3.750	0.875	2.000	.375	.312	.250	.169	#6-32	#10-32	19.8
TRSA10-66	0.625	66	1.125	3.750	4.625	1.000	2.625	.437	.312	.312	.193	#8-32	#10-32	26.3
TRSA12-66	0.750	66	1.500	4.500	5.500	1.125	3.250	.500	.312	.375	.221	#10-32	#10-32	37.0
TRSA16-66	1.000	66	1.750	5.250	6.375	1.312	3.750	.562	.312	.500	.281	1/4-20	#10-32	54.9
TRSA20-66	1.250	66	2.125	6.000	7.250	1.562	4.125	.625	.375	.562	.281	1/4-20	1/4-20	82.1
TRSA24-66	1.500	66	2.500	6.625	8.125	1.875	4.375	.750	.437	.687	.343	5/16-18	5/16-18	115.1
TRSA32-66	2.000	66	3.250	7.250	9.000	2.250	4.500	.875	.562	.875	.406	3/8-16	3/8-16	171.8
TRSA8-72	0.500	72	1.125	3.000	3.750	0.875	2.000	.375	.312	.250	.169	#6-32	#10-32	21.6
TRSA10-72	0.625	72	1.125	3.750	4.625	1.000	2.625	.437	.312	.312	.193	#8-32	#10-32	28.7
TRSA12-72	0.750	72	1.500	4.500	5.500	1.125	3.250	.500	.312	.375	.221	#10-32	#10-32	40.4
TRSA16-72	1.000	72	1.750	5.250	6.375	1.312	3.750	.562	.312	.500	.281	1/4-20	#10-32	59.9
TRSA20-72	1.250	72	2.125	6.000	7.250	1.562	4.125	.625	.375	.562	.281	1/4-20	1/4-20	89.6
TRSA24-72	1.500	72	2.500	6.625	8.125	1.875	4.375	.750	.437	.687	.343	5/16-18	5/16-18	125.5
TRSA32-72	2.000	72	3.250	7.250	9.000	2.250	4.500	.875	.562	.875	.406	3/8-16	3/8-16	187.4
TRSA8-84	0.500	84	1.125	3.000	3.750	0.875	2.000	.375	.312	.250	.169	#6-32	#10-32	25.2
TRSA10-84	0.625	84	1.125	3.750	4.625	1.000	2.625	.437	.312	.312	.193	#8-32	#10-32	33.4
TRSA12-84	0.750	84	1.500	4.500	5.500	1.125	3.250	.500	.312	.375	.221	#10-32	#10-32	47.1
TRSA16-84	1.000	84	1.750	5.250	6.375	1.312	3.750	.562	.312	.500	.281	1/4-20	#10-32	69.9
TRSA20-84	1.250	84	2.125	6.000	7.250	1.562	4.125	.625	.375	.562	.281	1/4-20	1/4-20	104.5
TRSA24-84	1.500	84	2.500	6.625	8.125	1.875	4.375	.750	.437	.687	.343	5/16-18	5/16-18	146.4
TRSA32-84	2.000	84	3.250	7.250	9.000	2.250	4.500	.875	.562	.875	.406	3/8-16	3/8-16	218.6
TRSA8-96	0.500	96	1.125	3.000	3.750	0.875	2.000	.375	.312	.250	.169	#6-32	#10-32	28.8
TRSA10-96	0.625	96	1.125	3.750	4.625	1.000	2.625	.437	.312	.312	.193	#8-32	#10-32	38.2
TRSA12-96	0.750	96	1.500	4.500	5.500	1.125	3.250	.500	.312	.375	.221	#10-32	#10-32	53.8
TRSA16-96	1.000	96	1.750	5.250	6.375	1.312	3.750	.562	.312	.500	.281	1/4-20	#10-32	79.9
TRSA20-96	1.250	96	2.125	6.000	7.250	1.562	4.125	.625	.375	.562	.281	1/4-20	1/4-20	119.4
TRSA24-96	1.500	96	2.500	6.625	8.125	1.875	4.375	.750	.437	.687	.343	5/16-18	5/16-18	167.3
TRSA32-96	2.000	96	3.250	7.250	9.000	2.250	4.500	.875	.562	.875	.406	3/8-16	3/8-16	249.8
TRSA8-108	0.500	108	1.125	3.000	3.750	0.875	2.000	.375	.312	.250	.169	#6-32	#10-32	32.4
TRSA10-108	0.625	108	1.125	3.750	4.625	1.000	2.625	.437	.312	.312	.193	#8-32	#10-32	43.0
TRSA12-108	0.750	108	1.500	4.500	5.500	1.125	3.250	.500	.312	.375	.221	#10-32	#10-32	60.5
TRSA16-108	1.000	108	1.750	5.250	6.375	1.312	3.750	.562	.312	.500	.281	1/4-20	#10-32	89.9
TRSA20-108	1.250	108	2.125	6.000	7.250	1.562	4.125	.625	.375	.562	.281	1/4-20	1/4-20	134.3
TRSA24-108	1.500	108	2.500	6.625	8.125	1.875	4.375	.750	.437	.687	.343	5/16-18	5/16-18	188.2
TRSA32-108	2.000	108	3.250	7.250	9.000	2.250	4.500	.875	.562	.875	.406	3/8-16	3/8-16	281.0

Footnotes:

(1) Two threaded leveling holes per TWIN RAIL® support segment are used for setscrew adjustment to aid in assembly leveling to the user mounting surfaces.

Dimensions

(inches)

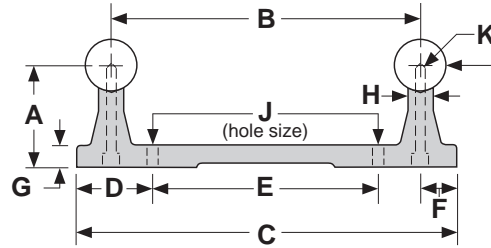

See pages 64 & 65 for end machining options and end stops.

Sold & Serviced By:
ELECTROMATE
 Toll Free Phone (877) SERV098
 Toll Free Fax (877) SERV099
www.electromate.com
sales@electromate.com

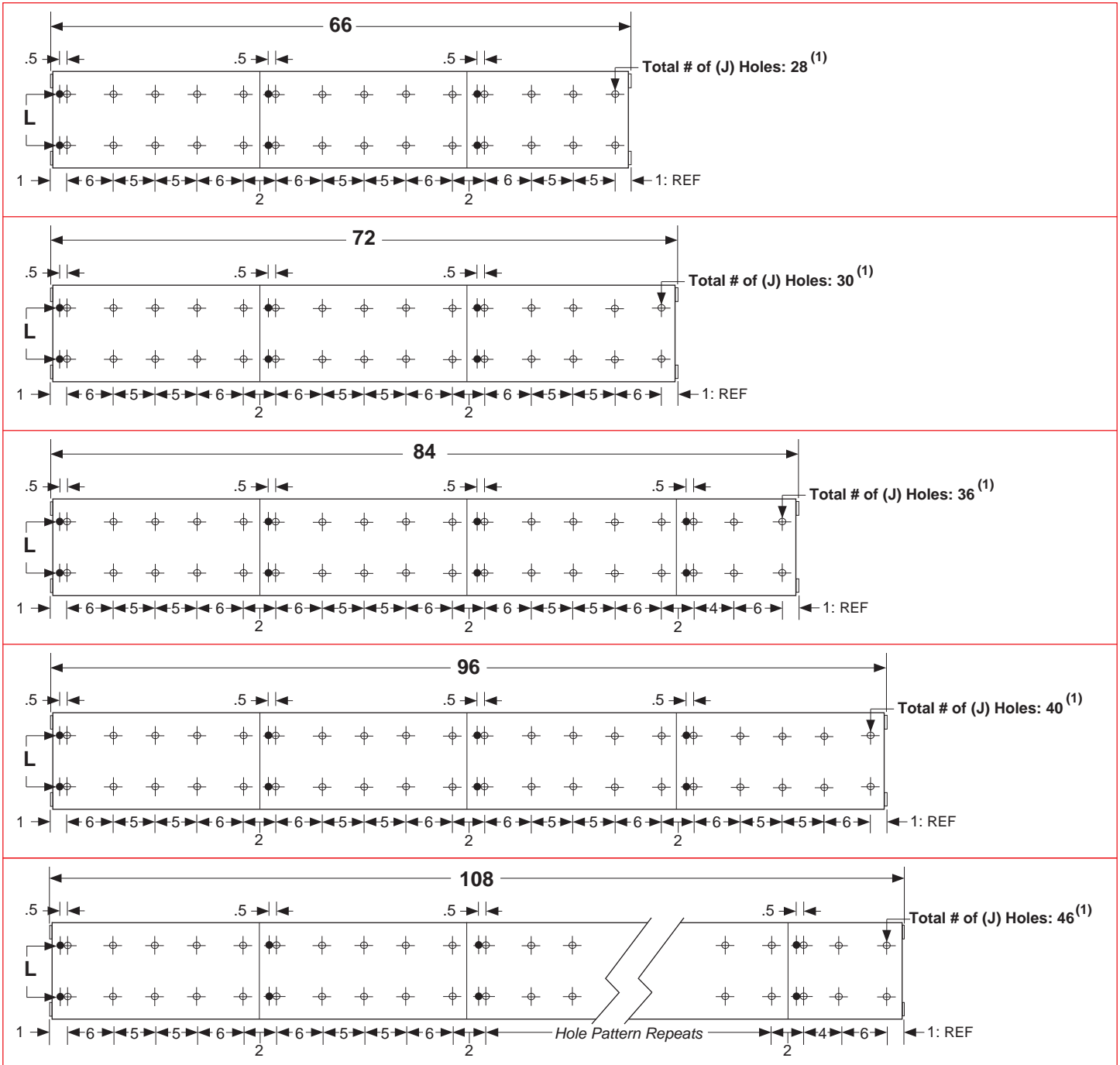

Footnotes:

(1) TWIN RAIL® supports come in 6, 12, 18 and 24 inch segments. The mounting hole location linear tolerance is +/- .010 inches noncumulative per segment. The supports are not one piece for lengths over 24 inches. The mounting hole linear tolerance is +/- .015 inches cumulative from one support segment to the next.

Dimensions & Specifications: TRSA TWIN RAIL® Shaft Assembly

Model Number	Nominal Shaft Diameter (inches)	Overall Length (inches)	Dimensions (inches)											Assembly Weight (lbs)
			A +/- .002	B +/- .002	C	D	E +/- .010	F	G	H	J hole	K Bolt Size	L ⁽¹⁾ Thread	
TRSA8-120	0.500	120	1.125	3.000	3.750	0.875	2.000	.375	.312	.250	.169	#6-32	#10-32	35.9
TRSA10-120	0.625	120	1.125	3.750	4.625	1.000	2.625	.437	.312	.312	.193	#8-32	#10-32	47.7
TRSA12-120	0.750	120	1.500	4.500	5.500	1.125	3.250	.500	.312	.375	.221	#10-32	#10-32	67.2
TRSA16-120	1.000	120	1.750	5.250	6.375	1.312	3.750	.562	.312	.500	.281	1/4-20	#10-32	99.8
TRSA20-120	1.250	120	2.125	6.000	7.250	1.562	4.125	.625	.375	.562	.281	1/4-20	1/4-20	149.2
TRSA24-120	1.500	120	2.500	6.625	8.125	1.875	4.375	.750	.437	.687	.343	5/16-18	5/16-18	209.1
TRSA32-120	2.000	120	3.250	7.250	9.000	2.250	4.500	.875	.562	.875	.406	3/8-16	3/8-16	312.2
TRSA8-144	0.500	144	1.125	3.000	3.750	0.875	2.000	.375	.312	.250	.169	#6-32	#10-32	43.1
TRSA10-144	0.625	144	1.125	3.750	4.625	1.000	2.625	.437	.312	.312	.193	#8-32	#10-32	57.3
TRSA12-144	0.750	144	1.500	4.500	5.500	1.125	3.250	.500	.312	.375	.221	#10-32	#10-32	80.7
TRSA16-144	1.000	144	1.750	5.250	6.375	1.312	3.750	.562	.312	.500	.281	1/4-20	#10-32	119.8
TRSA20-144	1.250	144	2.125	6.000	7.250	1.562	4.125	.625	.375	.562	.281	1/4-20	1/4-20	179.1
TRSA24-144	1.500	144	2.500	6.625	8.125	1.875	4.375	.750	.437	.687	.343	5/16-18	5/16-18	251.0
TRSA32-144	2.000	144	3.250	7.250	9.000	2.250	4.500	.875	.562	.875	.406	3/8-16	3/8-16	374.7
TRSA12-168	0.750	168	1.500	4.500	5.500	1.125	3.250	.500	.312	.375	.221	#10-32	#10-32	94.1
TRSA16-168	1.000	168	1.750	5.250	6.375	1.312	3.750	.562	.312	.500	.281	1/4-20	#10-32	139.8
TRSA20-168	1.250	168	2.125	6.000	7.250	1.562	4.125	.625	.375	.562	.281	1/4-20	1/4-20	208.9
TRSA24-168	1.500	168	2.500	6.625	8.125	1.875	4.375	.750	.437	.687	.343	5/16-18	5/16-18	292.8
TRSA32-168	2.000	168	3.250	7.250	9.000	2.250	4.500	.875	.562	.875	.406	3/8-16	3/8-16	437.1
TRSA12-192	0.750	192	1.500	4.500	5.500	1.125	3.250	.500	.312	.375	.221	#10-32	#10-32	107.6
TRSA16-192	1.000	192	1.750	5.250	6.375	1.312	3.750	.562	.312	.500	.281	1/4-20	#10-32	159.7
TRSA20-192	1.250	192	2.125	6.000	7.250	1.562	4.125	.625	.375	.562	.281	1/4-20	1/4-20	238.8
TRSA24-192	1.500	192	2.500	6.625	8.125	1.875	4.375	.750	.437	.687	.343	5/16-18	5/16-18	334.6
TRSA32-192	2.000	192	3.250	7.250	9.000	2.250	4.500	.875	.562	.875	.406	3/8-16	3/8-16	499.6

Footnotes:

(1) Two threaded leveling holes per TWIN RAIL® support segment are used for setscrew adjustment to aid in assembly leveling to the user mounting surfaces.

Sold & Serviced By:



Toll Free Phone (877) SERV098
Toll Free Fax (877) SERV099

www.electromate.com

sales@electromate.com
Specifications subject to change without notice

Dimensions

(inches)

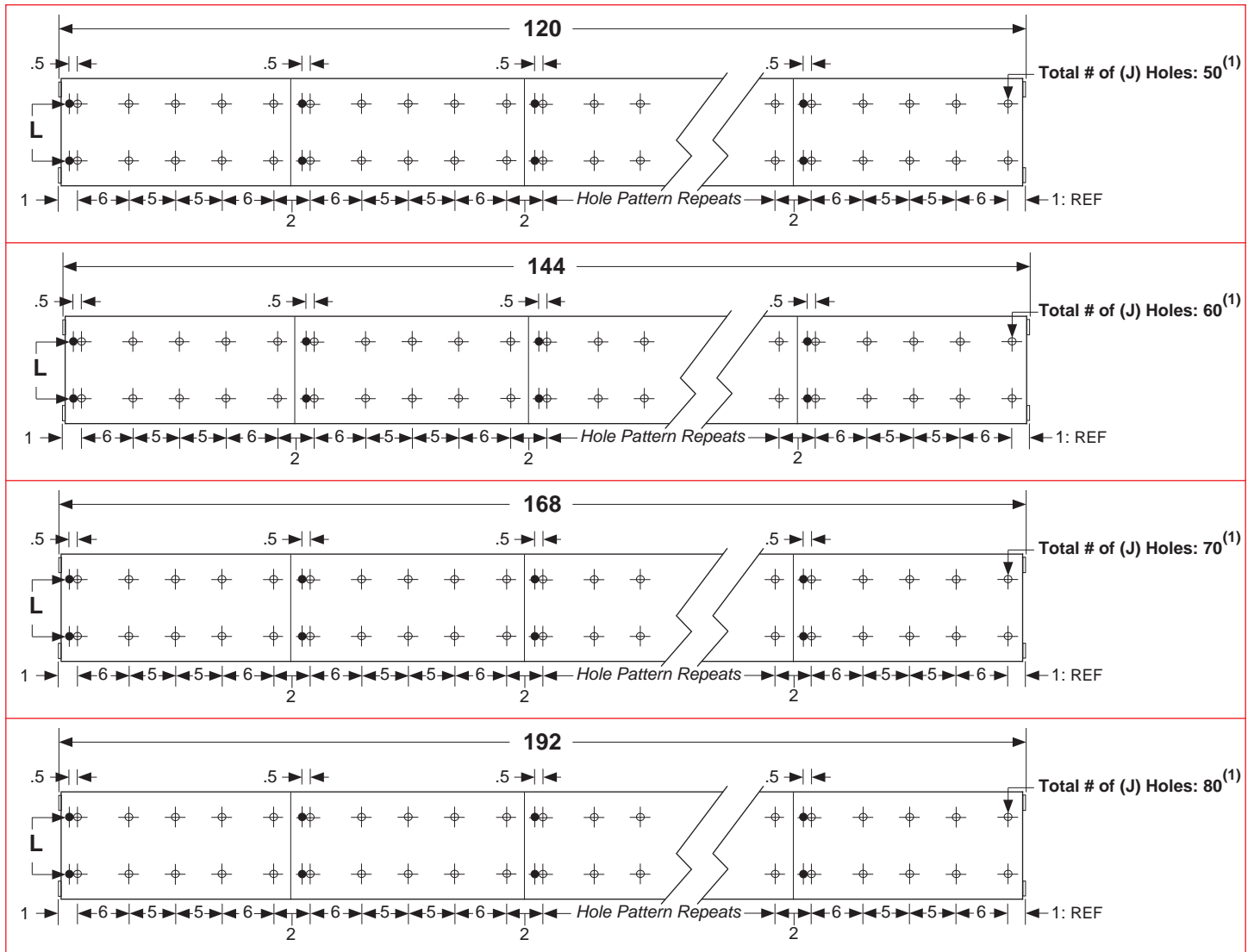
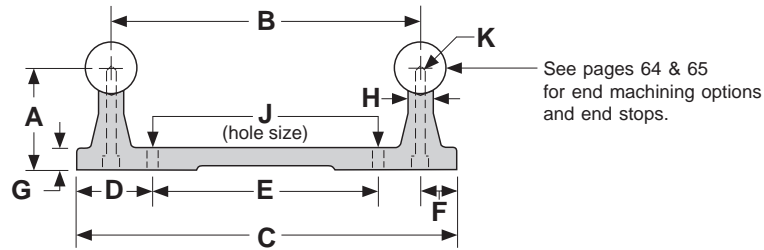

Footnotes:

(1) TWIN RAIL® supports come in 6, 12, 18 and 24 inch segments. The mounting hole location linear tolerance is +/- .010 inches noncumulative per segment. The supports are not one piece for lengths over 24 inches. The mounting hole linear tolerance is +/- .015 inches cumulative from one support segment to the next.

Options

Reduced Diameters, End Stops, Coaxial & Radial Holes

Reduced diameters, end stops, coaxial & radial holes can be provided on any shaft or shaft assembly. The standard tolerance for a reduced diameter is +/- .001 inches, while the concentricity is .002 inches TIR. The shaft may be annealed and soft around the shaft circumference adjacent to the reduced diameter. Coaxial holes are drilled and tapped in the center of the shaft ends and radial holes can be drilled and tapped as desired. The concentricity of the holes will be .005 inches TIR.

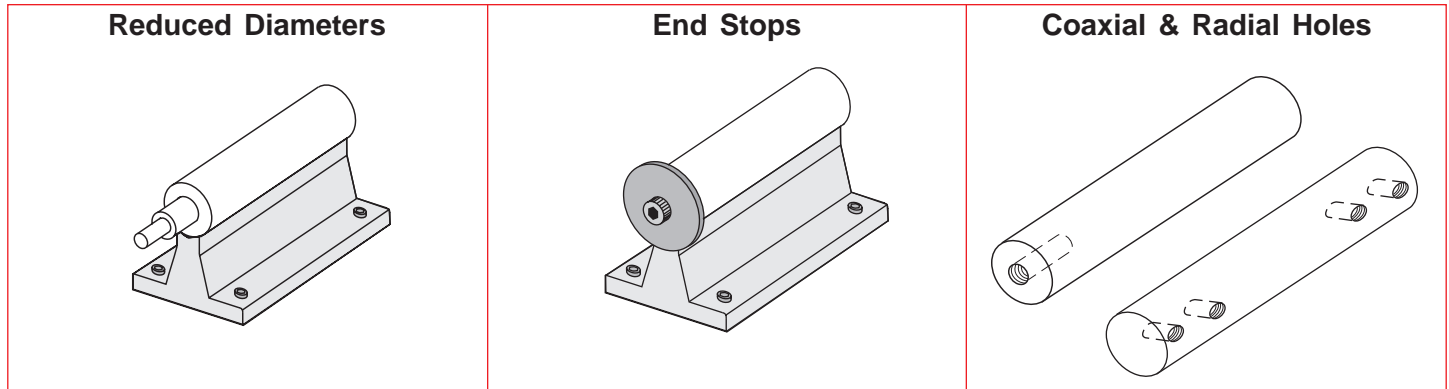

Butted, Doweled, and Threaded & Ground Joints

Standard shaft assemblies cannot be combined to create longer lengths, as the rolling elements of re-circulating linear bearings will "jam" at the joined ends due to the shaft chamfer. For those long length or custom applications, *LINTECH* provides several options for joining shaft assemblies. Butted, doweled, threaded, and ground joints are available with all shaft lengths and diameters. All of these options will have the standard chamfer removed from the shaft ends. The concentricity of doweled joints is < .001 inches, while the concentricity of butted joints will depend upon the user mounting surface.

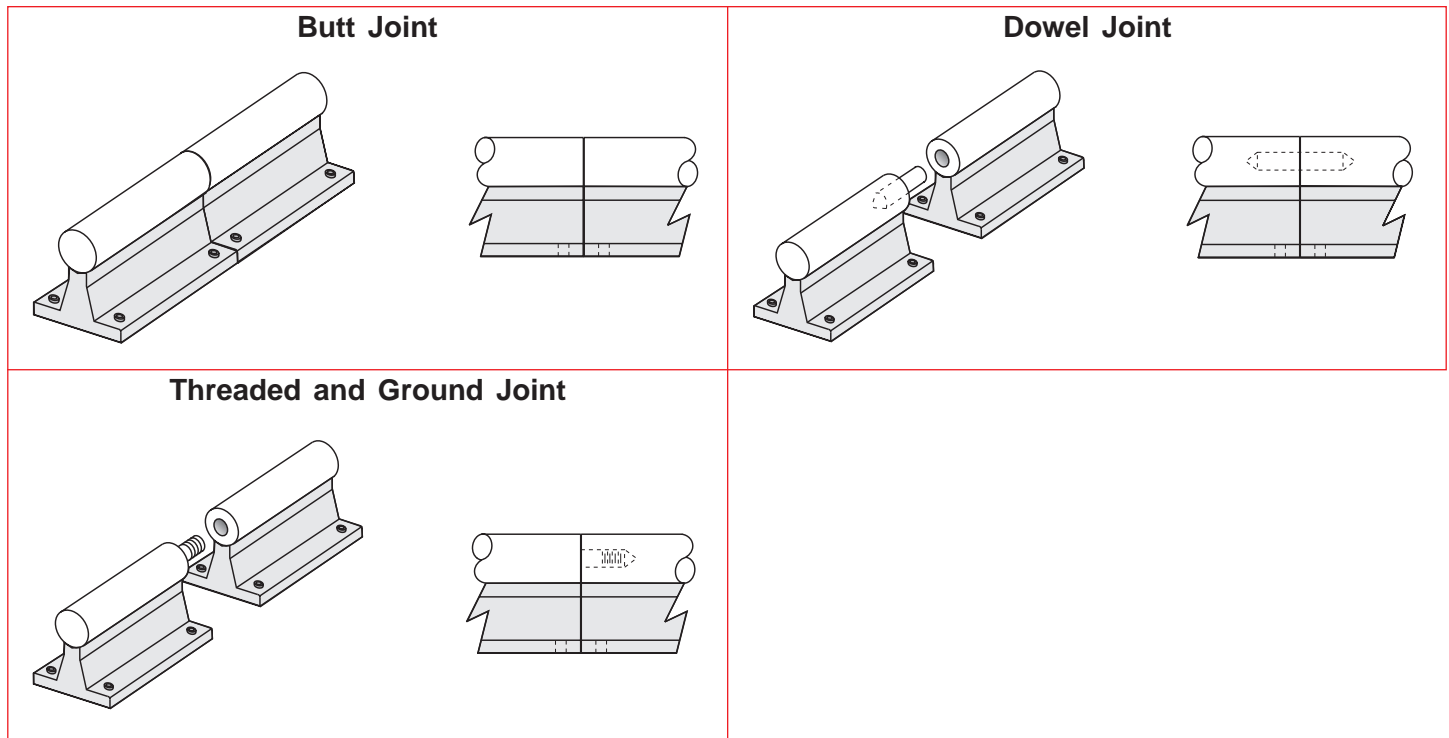

Sold & Serviced By:

 **ELECTROMATE**

Toll Free Phone (877) SERV098

Toll Free Fax (877) SERV099

www.electromate.com

sales@electromate.com

Specifications subject to change without notice

Options

Custom Shaft Assembly Lengths & Widths

Custom shaft assembly lengths and widths (shorter and longer) not shown in this catalog can be provided upon request.

Metric Shaft Assemblies

Metric shaft assemblies can be provided upon request by combining SM shafting with the LSRS or ARS shaft supports.

Chrome Plated Shafts

For applications in high moisture, high humidity, clean room, or highly corrosive environments, chrome plating of the shafts will offer superior resistance to corrosion. The process uniformly deposits dense, hard, high Chromium alloy onto the shaft, and has a Rockwell C hardness value of 67-72. This process also conforms to MIL Spec: (MIL-C-23422). The chrome plating bonds to the parent steel and will not crack or peel off under the high point loading of the balls on the shaft. This chrome plating process differs from normal hard chrome which just lays on the surface of the part plated.

Shaft Support Finishes

The standard anodized finish of the aluminum shaft supports can be changed to meet the requirements needed for operation in clean rooms, food processing facilities, highly corrosive environments, or for different appearances. The standard enamel finish of the steel shaft supports can also be changed. Available options are clear or color anodized, chem-film, nickel plated, chrome plated, different oxide color finishes, or painted per customer specifications.

Shaft Support End Stops

End stops are available for every shaft assembly size and length. They provide a mechanical stop for the linear bearings to prevent them from sliding off the end of the shaft. The shaft ends are drilled, tapped, and a washer is installed using a cap screw and lock washer.

Number of ⁽²⁾ End Stops (see model #)	Nominal Shaft Dia. (inches)	Dimensions (inches)			
		A	B	C	D ⁽¹⁾ Cap Screw
E1, E2, E3, E4	0.500	.375	.062	1.125	1/4
E1, E2, E3, E4	0.625	.453	.062	1.375	5/16
E1, E2, E3, E4	0.750	.532	.062	1.625	3/8
E1, E2, E3, E4	1.000	.656	.109	1.812	7/16
E1, E2, E3, E4	1.250	.750	.125	2.250	1/2
E1, E2, E3, E4	1.500	.750	.125	2.625	1/2
E1, E2, E3, E4	2.000	.750	.125	3.250	1/2

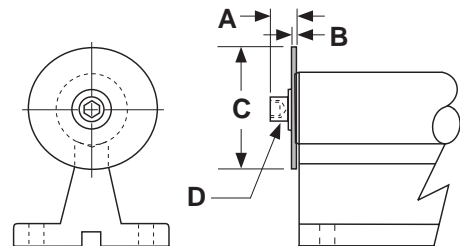

Footnotes:

- (1) Cap screw for end stops have black oxide finish. End stop & cap screw lock washers are Cadmium plated (QQ-P-416 Type II).
- (2) When only Specifying one end stop (E1) for SA, or two end stops for the TRSA (E2), the end stops will be installed on the left hand end of the assembly, as depicted by the above drawing, unless specified otherwise.

Unit Conversions

Torque Conversions

Present Units	Convert To	Multiply By
Gram-centimeters	newton-meters -----	0.0000981
Gram-centimeters	ounce-inches -----	0.0138874
Gram-centimeters	pound-inches -----	0.000868
Gram-centimeters	pound-feet -----	0.0000723
Newton-meters	gram-centimeters ----	10,197.162
Newton-meters	ounce-inches -----	141.612
Newton-meters	pound-inches -----	8.85
Newton-meters	pound-feet -----	0.73756
Ounce-inches	gram-centimeters ----	72.0077
Ounce-inches	newton-meters -----	0.007062
Ounce-inches	pound-inches -----	0.0625
Ounce-inches	pound-feet -----	0.005208
Pound-inches	gram-centimeters ----	1,152.0
Pound-inches	newton-meters -----	0.11299
Pound-inches	ounce-inches -----	16.0
Pound-inches	pound-feet -----	0.08333
Pound-feet	gram-centimeters ----	13,825.5
Pound-feet	newton-meters -----	1.3558
Pound-feet	ounce-inches -----	192.0
Pound-feet	pound-inches -----	12.0

Distance Conversions

Present Units	Convert To	Multiply By
Arc-minutes	degrees -----	0.016666
Arc-seconds	degrees -----	0.000277
Centimeters	inches -----	0.3937
Centimeters	feet -----	0.03280
Centimeters	microns -----	10,000.0
Degrees	arc-minutes ----	60.0
Degrees	arc-seconds ----	3,600.0
Degrees	radians -----	0.017453
Feet	centimeters -----	30.48
Feet	meters -----	0.3048
Inches	centimeters ----	2.54
Inches	Km -----	0.0000254
Inches	meters -----	0.0254
Inches	microns -----	25,400.0
Inches	millimeters ----	25.4
Km	inches -----	39,370.0
Meters	feet -----	3.2808
Meters	inches -----	39.37
Meters	microns -----	1,000,000.0
Microns	centimeters ----	0.0001
Microns	inches -----	0.00003937
Microns	meters -----	0.000001
Microns	millimeters ----	0.001
Millimeters	inches -----	0.03937
Millimeters	microns -----	1,000.0
Radians	degrees -----	57.295779

Inertia Conversions

Present Units	Convert To	Multiply By
Gram-cm ²	ounce-inches ² ----	0.00546745
Gram-cm ²	ounce-inch-sec ² --	0.000014161
Gram-cm ²	pound-inches ² ----	0.000341716
Gram-cm ²	pound-inch-sec ² --	0.000000885
Gram-cm ²	pound-feet-sec ² --	0.000000074
Ounce-inches ²	gram-cm ² -----	182.901
Ounce-inches ²	ounce-inch-sec ² --	0.00259008
Ounce-inches ²	pound-inches ² ----	0.0625
Ounce-inches ²	pound-inch-sec ² --	0.00016188
Ounce-inches ²	pound-feet-sec ² --	0.00001349
Ounce-inch-sec ²	gram-cm ² -----	70,615.4
Ounce-inch-sec ²	ounce-inches ² ----	386.0
Ounce-inch-sec ²	pound-inches ² ----	24.13045
Ounce-inch-sec ²	pound-inch-sec ² --	0.0625
Ounce-inch-sec ²	pound-feet-sec ² --	0.00520833
Pound-inches ²	gram-cm ² -----	2,926.41
Pound-inches ²	ounce-inches ² ----	16.0
Pound-inches ²	ounce-inch-sec ² --	0.0414413
Pound-inches ²	pound-inch-sec ² --	0.00259008
Pound-inches ²	pound-feet-sec ² --	0.00021584
Pound-inch-sec ²	gram-cm ² -----	1,129,850.0
Pound-inch-sec ²	ounce-inches ² ----	6,177.4
Pound-inch-sec ²	ounce-inch-sec ² --	16.0
Pound-inch-sec ²	pound-inches ² ----	386.0
Pound-inch-sec ²	pound-feet-sec ² --	0.0833333
Pound-feet-sec ²	gram-cm ² -----	13,558,200.0
Pound-feet-sec ²	ounce-inches ² ---	74,128.9
Pound-feet-sec ²	ounce-inch-sec ² --	192.0
Pound-feet-sec ²	pound-inches ² ---	4,633.06
Pound-feet-sec ²	pound-inch-sec ² -	12.0

Load Conversions

Present Units	Convert To	Multiply By
Grams	newtons -----	0.009806
Grams	ounces -----	0.03528
Grams	pounds -----	0.002204
Kilograms	pounds -----	2.2046
Newtons	grams -----	101.971
Newtons	ounces -----	3.59692
Newtons	pounds -----	0.224808
Ounces	grams -----	28.3495
Ounces	newtons -----	0.27802
Ounces	pounds -----	0.0625
Pounds	grams -----	453.592
Pounds	kilograms -----	0.45359
Pounds	newtons -----	4.44824
Pounds	ounces -----	16.0
Pounds	tons -----	0.0005
Tons	pounds -----	2,000.0